

WTNP125 - Negative mascon of a tank

Summary:

The test presented here makes it possible to check the good performance of the elements of joints with hydraulic coupling in saturated medium.

The negative mascon of a tank is modelled (reduction of the importance of a layer because of its exploitation). This one is initially entirely crossed by a discontinuity and contains single liquid. The laws of behavior of the interface used are the cubic law for the flow and the law of Bandis for mechanics.

1 Problem of reference

One et al. takes again the CAS-test suggested by Guiducci.[gui]

1.1 Geometry

One considers a tank separated in two equal parts by a horizontal discontinuity $[EF]$.

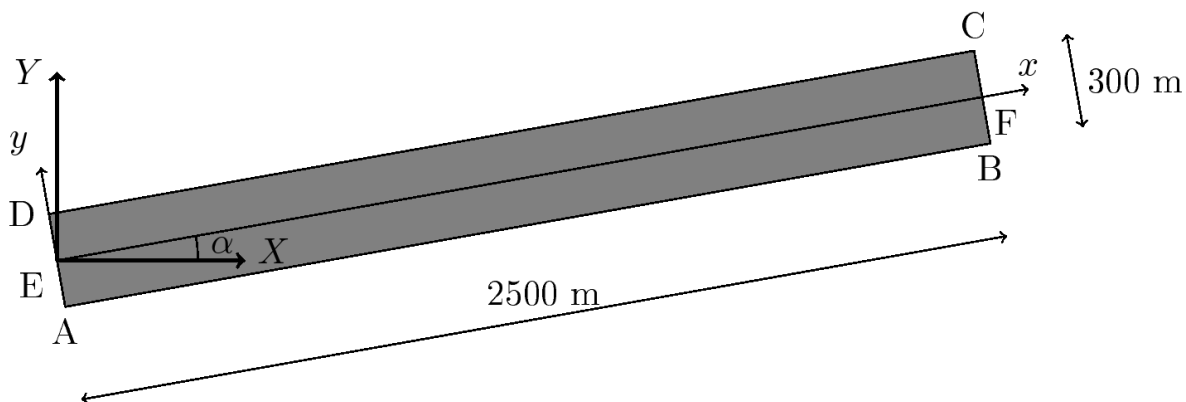

The reference mark (x, y) by discontinuity you it edge of the structure is defined. One notes α the angle enters the reference mark (x, y) and the total reference mark (X, Y) .

Coordinates of the points (in meters) in the reference mark (x, y) :

	x	y		x	y
A	0	-150	D	0	150
B	2500	-150	E	0	0
C	2500	0	F	2500	0

1.2 Properties of material

- Properties of the fluid intersticiel (liquid water):

Density	1000 kg.m^{-3}
Viscosity	1.10^{-3} Pa.s
Compressibility	3.10^9 Pa

- Properties of the rock matrix:

The matrix is elastic and has the following properties:

Young modulus	200 MPa
Poisson's ratio	0,25
Porosity	0,4055

Intrinsic permeability $1,688.10^{-17} m^2$

- Properties of discontinuity:

The laws of behavior of discontinuity are detailed in documentation [R7.02.15][docR].

The mechanical behavior of discontinuity is given the law of Bandis.

One notes ε the opening of the crack, U_{max} the asymptotic opening under worthless constraint and $U = U_{max} - \varepsilon$ the closing of crack.

In the normal direction with the crack, one has

$$d\sigma'_n = -K_{ni} \frac{dU}{\left(1 - \frac{U}{U_{max}}\right)^\gamma} \quad (1.2.1)$$

In the tangential direction, one has

$$\sigma'_t = K_t \llbracket u_t \rrbracket \quad (1.2.2)$$

Initial normal rigidity K_{ni}	$1.10^9 Pa.m^{-1}$
Asymptotic opening U_{max}	$2,17 mm$
Coefficient γ	2
Tangential rigidity K_t	$1.10^{12} Pa.m^{-1}$

The flow in the crack is given by the cubic law.

1.3 Initial conditions

The initial conditions are the following ones:

- initial opening ε_0 : $3,04.10^{-4} m$
- initial pressure in the solid mass: $48,7 MPa$
- compressive stress in the two directions of the plan: $62 MPa$

1.4 Boundary conditions

The boundary conditions mechanical and hydraulic are given by the figures 1.4.1 with 1.4.3.

On $[AB]$: displacements blocked in y and hydraulic flow no one

On $[BC]$: displacements blocked in x and hydraulic flow no one

On $[CD]$: mechanical pressure of $62 MPa$ and hydraulic flow no one

On $[DA]$: mechanical pressure of $62 MPa$ and imposed pressure p^*

Note: the mechanical pressure is applied only to the solid mass (not on the crack)

Evolution of the pressure p^* imposed by the well located in $x=0$ is the following one (see also figure 1.4.3) :

- Linear reduction in 48,7 MPa with 33,7 MPa during 7,5 first years of exploitation
- Maintains with 33,7 MPa during 12,5 following years.

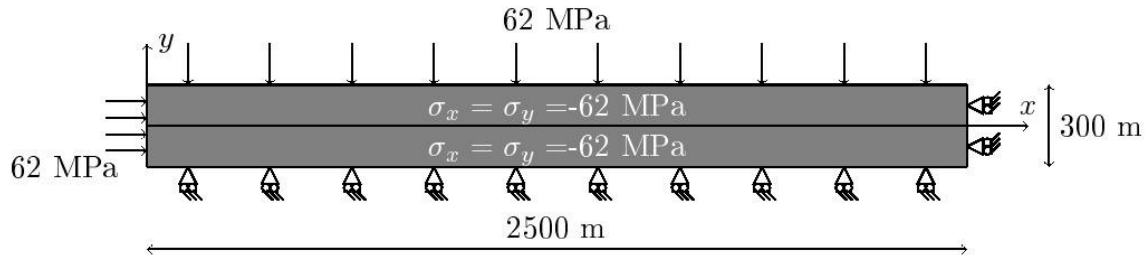

Illustration 1.4.1: Boundary conditions and initial mechanical

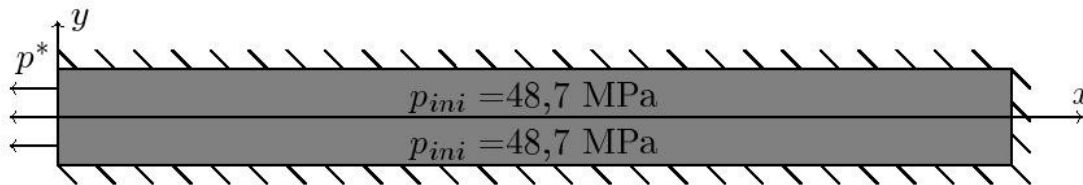

Illustration 1.4.2: Boundary conditions and initial hydraulic

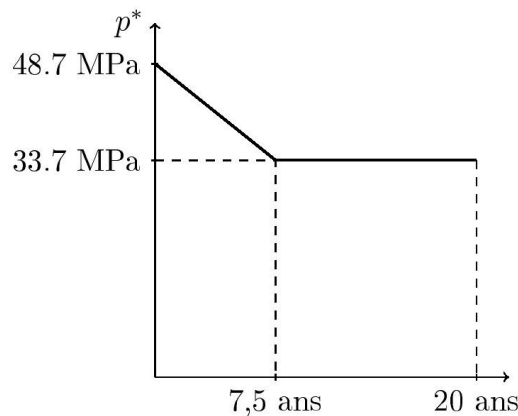

Illustration 1.4.3: Scenario of exploitation

2 Reference solution

One compares the results with those obtained by *LAGAMINE*, the code of finite elements for the géomechanics of the University of Liege.

2.1 Bibliographical references

Contents

gui Guiducci, C., Collin, F., Radu, J.P., Pellegrino, A., Charlier, R., "Numerical modeling of Hydro-Mechanical fracture behavior", ISRM 2003-Technology roadmap for rock mechanics, South African Institute of Mining and Metallurgy, 2003

docR: "Modélisation des fissures avec couplage hydromécanique en milieu poreux saturé", Manuel de référence de Code_Aster, R7.02.15

3 Modeling A

3.1 Characteristics of modeling A

The total reference mark is selected so that discontinuity is horizontal in this reference mark ($\alpha = 0^\circ$ thus an angle of Euler of 90°).

Modeling is carried out in plane deformation with 1092 elements QU4 for the solid mass and 91 elements QU4 for discontinuity.

Discretization in time:

- 25 pas de time for 7,5 first years
- 25 pas de time for 12,5 following years.

3.2 Sizes tested and results

One compares the results got with *Code_Aster* with those obtained by the code *LAGAMINE*.

One presents the profile of pressure along discontinuity to 7,5 and 20 years (figure 3.2.1), variations of the opening along discontinuity with 7,5 and 20 years (figure 3.2.2) and the outgoing flow of the crack on the level of the well per day (figure 3.2.3).

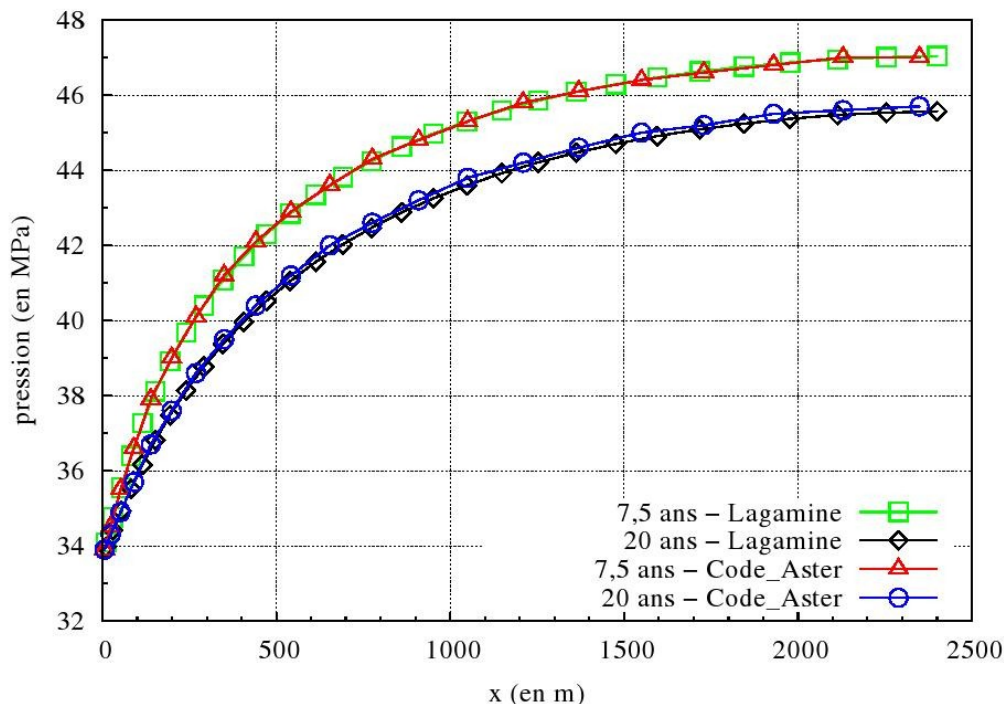

Illustration 3.2.1: Pressure along discontinuity with 7.5 years and 20 years and comparison with the results of *LAGAMINE*

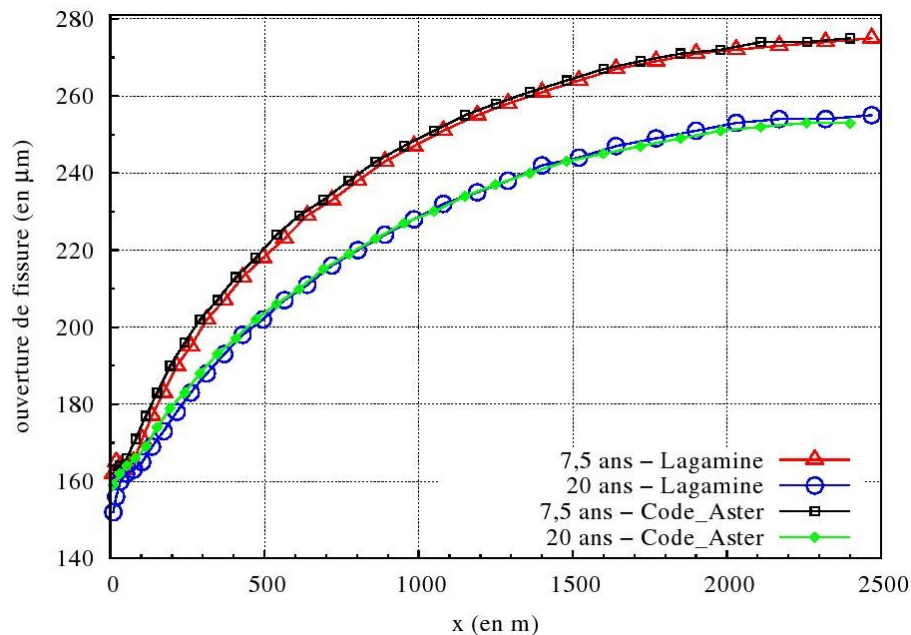

Illustration 3.2.2: Opening of discontinuity along the tank after 7.5 and 20 years and comparison with the results of LAGAMINE

The results are almost identical to those obtained with LAGAMINE.

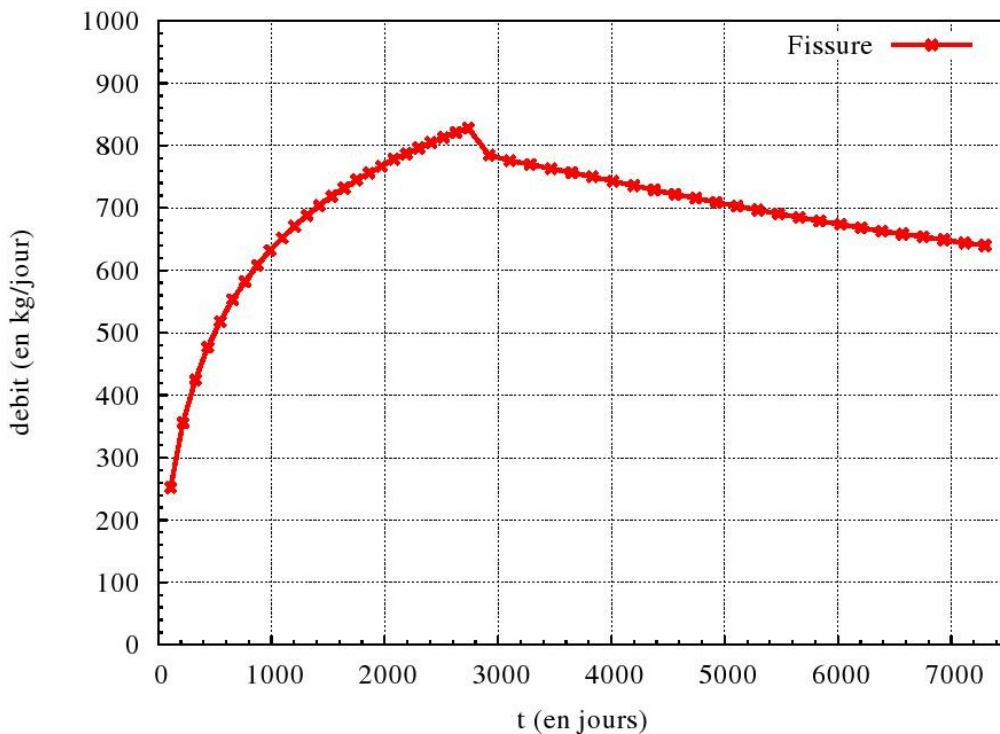

Illustration 3.2.3: Outgoing mass throughput of the crack on the level of the well per day during the time obtained with Code_Aster

The values of reference are those obtained with LAGAMINE.

$X(m)$	$Y(m)$	Time (years)	Reference <i>PRE1</i> (MPa)	Tolerance (%)
256.97	0	7.5	39.95	1.0%
516.51	0	7.5	42.68	1.0%
256.97	0	20	38.45	1.0%
516.51	0	20	40.98	1.0%

$X(m)$	$Y(m)$	Time (years)	Reference <i>VI</i> (m)	Tolerance (%)
516.51	0	7.5	2,20E-04	1.0%
516.51	0	20	2,04E-04	1.0%

A case of nonregression is added:

$X(m)$	$Y(m)$	Time (years)	Reference <i>FHIX</i> ($kg.m^{-1}.s^{-1}$)	Tolerance (%)
516.51	0	7.5	-7,0189E-03	0.10%
516.51	0	20	-5,3847E-03	0.10%

4 Modeling B

4.1 Characteristics of modeling

In order to check that the results are independent of the orientation of the discontinuity (given by the angles of Euler defined in `AFPE_CARA_ELEM`), modeling is taken again A with a rotation of $\alpha = -90^\circ$. The direct reference mark defined by the normal and the tangent in the crack is then identical to the total reference mark. The angle of Euler is thus equal to zero.

4.2 Sizes tested and results

$X(m)$	$Y(m)$	Time (years)	Reference $PRE1$ (MPa)	Difference (%)
256.97	0	7.5	39,95	1.0%
516.51	0	7.5	42.68	1.0%
256.97	0	20	38.45	1.0%
516.51	0	20	40.98	1.0%

$X(m)$	$Y(m)$	Time (years)	Reference VI (m)	Difference (%)
516.51	0	7.5	2,20E-04	1.0%
516.51	0	20	2,04E-04	1.0%

A case of nonregression is added:

$X(m)$	$Y(m)$	Time (years)	Reference $FHIX$ ($kg.m^{-1}.s^{-1}$)	Difference (%)
516.51	0	7.5	-7,0189E-03	0.10
516.51	0	20	-5,3847E-03	0.10

5 Summary of the results

One tests here the element of joint with hydraulic couplings with several orientations of crack. One obtains in all the cases with *Code_Aster* results identical to those obtained with *LAGAMINE*.