

SSLS108 - Helicoid hull under loads concentrated

Summary:

This test in linear elasticity is very severe from its geometry (left hull). It allows to show the influence of warping on the performances of the elements of hulls.

It comprises 14 modelings making it possible to test elements COQUE_3D, SHB, DKT, DST and Q4G for various geometrical supports.

The values of reference are computation results provided in the literature, one checks displacement in a point of the structure.

1 Problem of reference

1.1 Geometry

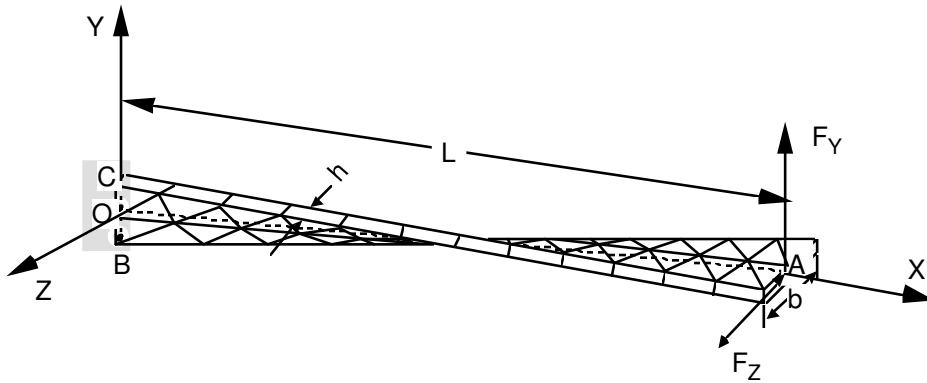

The hull is thickness 0.32 m , length 12 m and of width 1.1 m .

1.2 Material properties

$$E = 29.10^6 \text{ Pa}$$

$$\nu = 0.22$$

1.3 Boundary conditions and loadings

Embedded on the side OBC : $u=v=w=0$, $\theta_x=\theta_y=\theta_z=0$

Two loading cases which corresponds to loadings concentrated at the point A :

- Force parallel with the axis Z : $F_z = 1\text{ N}$
- Force parallel with the axis Y : $F_y = 1\text{ N}$

2 Reference solution

2.1 Method of calculating used for the reference solution

The reference solution [1] is a solution based on the theory of the beams (not-deformation of the cross section), including or not the effects of transverse shearing.

2.2 Results of reference

Displacement of the point A according to Y .

Displacement of the point A according to Z .

Loading (N)	Reference (m)
$F_Y=0$ $F_Z=1$	$DY = 1.72 \times 10^{-3}$ $DZ = 5.424 \times 10^{-3}$
$F_Y=1$ $F_Z=0$	$DY = 1.754 \times 10^{-3}$ $DZ = 1.72 \times 10^{-3}$

2.3 Uncertainties on the solution

Semi-analytical solution.

2.4 Bibliographical references

- [1] J.L. Batoz and G. Dhatt, "Modeling of the structures by finite elements Volume.3: Hulls ", HERMES editions. Paris, France, 1992.
- [2] HAMMADI Fodil: 'Formulation and evaluation of finite elements have C^0 continuity of the geometry for the linear and non-linear analysis of the hulls" Thesis of doctor, UTC, June 1998

3 Modeling A

3.1 Characteristics of modeling

Modeling COQUE_3D

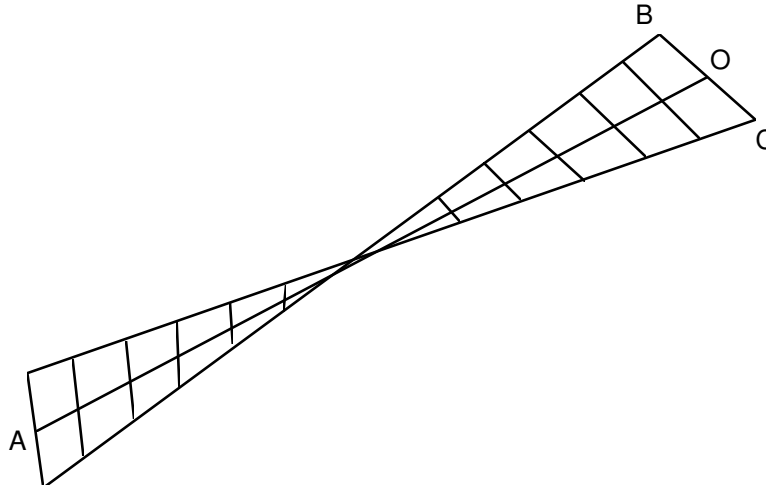

Cutting:

2 according to the width, 12 according to the length
24 meshes QUAD9, thickness: $h=0.32$

Names of the nodes:

Not <i>O</i>	<i>N06</i>
Not <i>B</i>	<i>N01</i>
Not <i>C</i>	<i>N02</i>
Not <i>A</i>	<i>N032</i>

3.2 Characteristics of the grid

Many nodes: 125

Many meshes and types: 24 QUAD9

3.3 Values tested

Loading case	Not	Size in unit	Reference
$F_z=1\text{ N}$	<i>A</i>	displacement V (<i>m</i>)	$-1.72 \cdot 10^{-3}$
		displacement W (<i>m</i>)	$5.42 \cdot 10^{-3}$
$F_y=1\text{ N}$	<i>A</i>	displacement V (<i>m</i>)	$1.75 \cdot 10^{-3}$
		displacement W (<i>m</i>)	$-1.72 \cdot 10^{-3}$

4 Modeling B

4.1 Characteristics of modeling

Modeling COQUE_3D

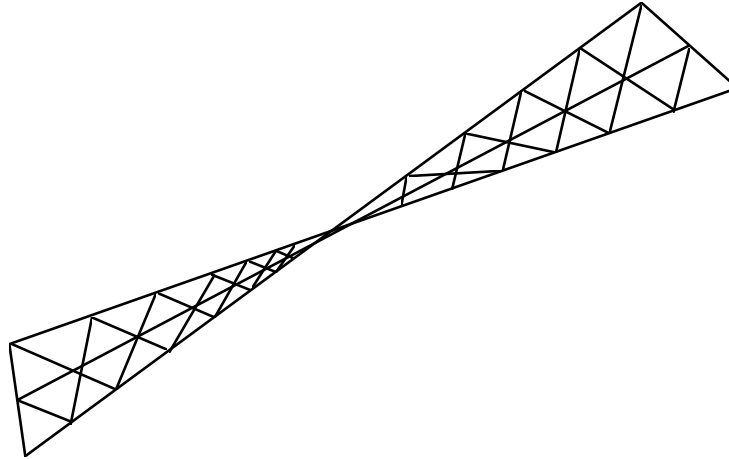

Cutting:

2 according to the width, 12 according to the length
48 meshes TRIA7, thickness: $h=0.32$

Names of the nodes:

Not <i>O</i>	<i>N06</i>
Not <i>B</i>	<i>N01</i>
Not <i>C</i>	<i>N02</i>
Not <i>A</i>	<i>N032</i>

4.2 Characteristics of the grid

Many nodes: 173

Many meshes and types: 48 TRIA7

4.3 Values tested

Loading case	Not	Size in unit	Reference
$F_z=1 N$	<i>A</i>	displacement $V (m)$	$-1.72 \cdot 10^{-3}$
		displacement $W (m)$	$5.42 \cdot 10^{-3}$
$F_y=1 N$	<i>A</i>	displacement $V (m)$	$1.75 \cdot 10^{-3}$
		displacement $W (m)$	$-1.72 \cdot 10^{-3}$

5 Modeling C

5.1 Characteristics of modeling

Modeling SHB8

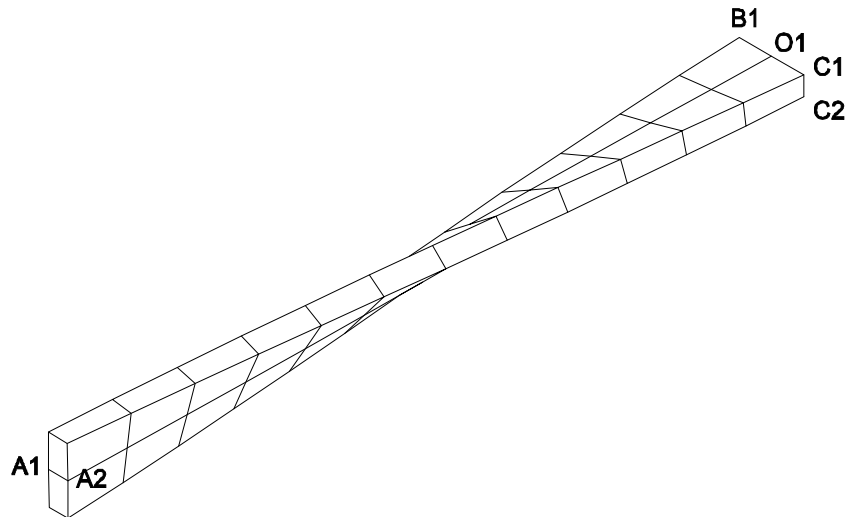

Cutting:

2 according to the width, 12 according to the length
24 meshes `HEXA8`, thickness: $H = 0.32$

Names of the nodes:

Not *O1* *N03* Not *O2* *N05*
Not *B1* *N04* Not *B2* *N06*
Not *C1* *N01* Not *C2* *N02*
Not *A1* *N78* Not *A2* *N75*

5.2 Characteristics of the grid

Many nodes: 78
Many meshes and types: 24 `HEXA8`

5.3 Values tested

Loading case	Not	Size in unit	Reference
$F_z = 1\text{ N}$	<i>A1</i> and <i>A2</i>	displacement V (<i>m</i>)	$-1.72 \cdot 10^{-3}$
		displacement W (<i>m</i>)	$5.42 \cdot 10^{-3}$
$F_y = 1\text{ N}$	<i>A1</i> and <i>A2</i>	displacement V (<i>m</i>)	$1.75 \cdot 10^{-3}$
		displacement W (<i>m</i>)	$-1.72 \cdot 10^{-3}$

5.4 Remarks

A modeling 3D on the same grid (meshes `HEXA8`) fact of appearing a blocking: the results are very far away from the reference. For example, in the case of load 1, one obtains:

Not	Size in unit	Reference	Aster
-----	--------------	-----------	-------

Warning : The translation process used on this website is a "Machine Translation". It may be imprecise and inaccurate in whole or in part and is provided as a convenience.

Copyright 2019 EDF R&D - Licensed under the terms of the GNU FDL (<http://www.gnu.org/copyleft/fdl.html>)

$A1$ and $A2$	displacement V (m)	$- 1.72 \cdot 10^{-3}$	$- 7.5 \cdot 10^{-4}$
	displacement W (m)	$5.42 \cdot 10^{-3}$	$5,408 \cdot 10^{-3}$

This blocking does not appear any more with quadratic meshes `HEXA20`, since one obtains then:

Not	Size in unit	Reference	Aster
$A1$ and $A2$	displacement V (m)	$- 1.72 \cdot 10^{-3}$	$- 1,729 \cdot 10^{-3}$
	displacement W (m)	$5.42 \cdot 10^{-3}$	$5.43 \cdot 10^{-3}$

Modeling `SHB` allows to avoid any digital blocking, at a cost (in time CPU) similar to that of a grid `HEXA8`.

6 Modeling D

6.1 Characteristics of modeling

Modeling SHB8

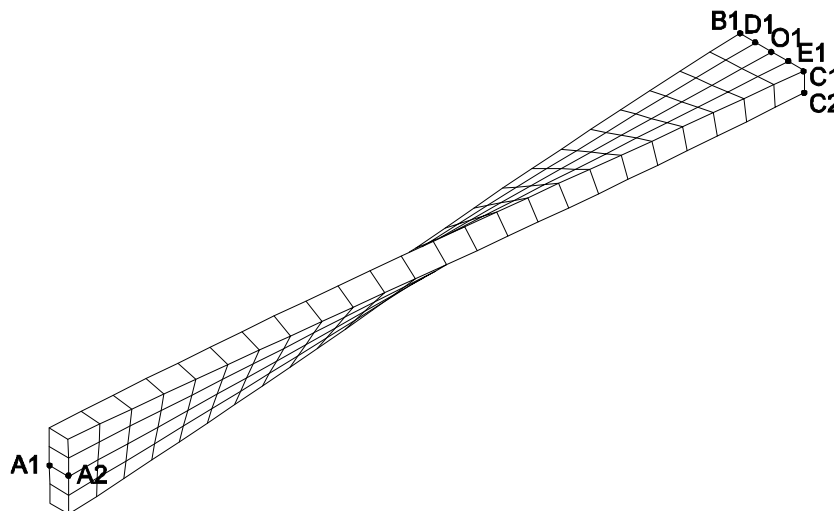

Cutting:

4 according to the width, 24 according to the length
96 meshes HEXA8, thickness: $h=0.32$

Names of the nodes:

Not O1	N245	Not O2	N249
Not B1	N224	Not B2	N226
Not C1	N239	Not C2	N241
Not D1	N236	Not D2	N238
Not E1	N250	Not E2	N246
Not A1	N05	Not A2	N06

6.2 Characteristics of the grid

Many nodes: 250

Many meshes and types: 96 HEXA8

6.3 Values tested

Loading case	Not	Size in unit	Reference
$F_z=1\text{ N}$	A1 and A2	displacement V (m)	$-1.72 \cdot 10^{-3}$
		displacement W (m)	$5.42 \cdot 10^{-3}$
$F_y=1\text{ N}$	A1 and A2	displacement V (m)	$1.75 \cdot 10^{-3}$
		displacement W (m)	$-1.72 \cdot 10^{-3}$

6.4 Remarks

A modeling 3D on the same grid (meshes `HEXA8`) fact of appearing a blocking: even with a grid with 96 elements. The results remain very far away from the reference. For example, in the case of load 1, one obtains:

Not	Size in unit	Reference	Aster
$A1$ and $A2$	displacement V (m)	$- 1.72 \cdot 10^{-3}$	$- 2.49 \cdot 10^{-4}$
	displacement W (m)	$5.42 \cdot 10^{-3}$	$1.12 \cdot 10^{-3}$

This blocking does not appear any more with quadratic meshes `HEXA20`, since one obtains then:

Not	Size in unit	Reference	Aster
$A1$ and $A2$	displacement V (m)	$- 1.72 \cdot 10^{-3}$	$- 1,735 \cdot 10^{-3}$
	displacement W (m)	$5.42 \cdot 10^{-3}$	$5,438 \cdot 10^{-3}$

With `HEXA20`, convergence is much better. Modeling `SHB` allows to avoid any digital blocking, at a cost (in time CPU) similar to that of a grid `HEXA8`.

7 Modeling E

7.1 Characteristics of modeling

Modeling SHB6

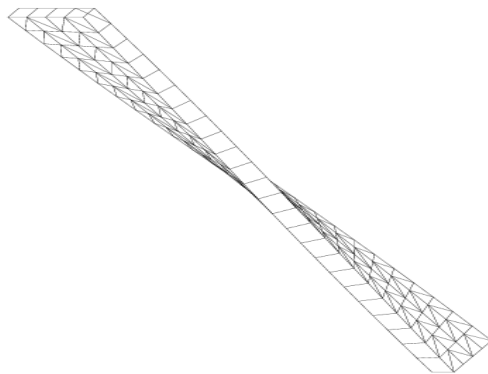

Cutting:

4 according to the width, 24 according to the length
192 meshes PENTA6, thickness: $h=0.32$

7.2 Characteristics of the grid

Many nodes: 250
Many meshes and types: 192 PENTA6

7.3 Values tested

Loading case	Not	Size in unit	Reference
$F_z=1\text{ N}$	A1 and A2	displacement $V (m)$	$-1.72 \cdot 10^{-3}$
		displacement $W (m)$	$5.42 \cdot 10^{-3}$
$F_y=1\text{ N}$	A1 and A2	displacement $V (m)$	$1.75 \cdot 10^{-3}$
		displacement $W (m)$	$-1.72 \cdot 10^{-3}$

7.4 Remarks

A modeling 3D on the same grid (meshes PENTA6) fact of appearing a blocking: the results are very far away from the reference. For example, in the case of load 1, one obtains:

Not	Size in unit	Reference	Aster
A1 and A2	displacement $V (m)$	$-1.72 \cdot 10^{-3}$	$-7.84 \cdot 10^{-4}$
		$5.42 \cdot 10^{-3}$	$2.63 \cdot 10^{-3}$

Warning : The translation process used on this website is a "Machine Translation". It may be imprecise and inaccurate in whole or in part and is provided as a convenience.

Copyright 2019 EDF R&D - Licensed under the terms of the GNU FDL (<http://www.gnu.org/copyleft/fdl.html>)

displacement W (m)

This blocking does not appear any more with quadratic meshes PENTA15, since one obtains then:

Not	Size in unit	Reference	Aster
$A1$ and $A2$	displacement V (m)	$- 1.72 \cdot 10^{-3}$	$- 1.72 \cdot 10^{-3}$
	displacement W (m)	$5.42 \cdot 10^{-3}$	$5.43 \cdot 10^{-3}$

Modeling SHB6 allows to avoid any digital blocking, at a cost (in time CPU) similar to that of a grid PENTA6.

8 Modeling F

8.1 Characteristics of modeling

Modeling SHB6

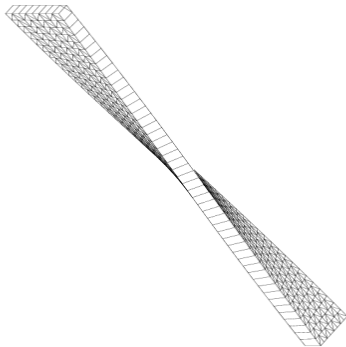

Cutting:

8 according to the width, 48 according to the length
768 meshes PENTA6, thickness: $h=0.32$

8.2 Characteristics of the grid

Many nodes: 882

Many meshes and types: 768 PENTA6

8.3 Values tested

Loading case	Not	Size in unit	Reference
$F_z = 1\text{ N}$	A1 and A2	displacement V (m)	$- 1.72 \cdot 10^{-3}$
		displacement W (m)	$5.42 \cdot 10^{-3}$
$F_y = 1\text{ N}$	A1 and A2	displacement V (m)	$1.75 \cdot 10^{-3}$
		displacement W (m)	$- 1.72 \cdot 10^{-3}$

9 Modeling G

9.1 Characteristics of modeling

Modeling SHB20

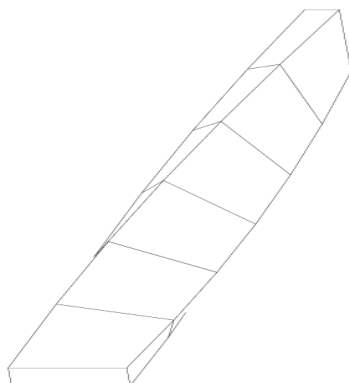

Cutting:

1 according to the width, 6 according to the length
6 meshes HEXA20, thickness: $h=0.32$

9.2 Characteristics of the grid

Many nodes: 80
Many meshes and types: 6 HEXA20

9.3 Values tested

Loading case	Not	Size in unit	Reference
$F_z=1N$	A1 and A2	displacement V (m)	$-1.72 \cdot 10^{-3}$
		displacement W (m)	$5.42 \cdot 10^{-3}$
$F_y=1N$	A1 and A2	displacement V (m)	$1.75 \cdot 10^{-3}$
		displacement W (m)	$-1.72 \cdot 10^{-3}$

10 Modeling H

10.1 Characteristics of modeling

Modeling SHB15

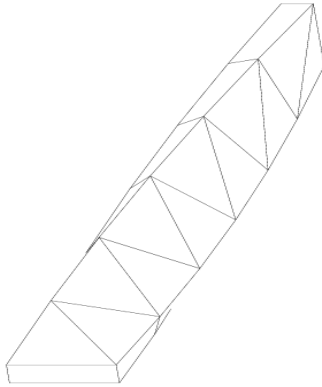

Cutting:

1 according to the width, 6 according to the length
12 meshes PENTA15, thickness: $h=0.32$

10.2 Characteristics of the grid

Many nodes: 92

Many meshes and types: 12 PENTA15

10.3 Values tested

Loading case	Not	Size in unit	Reference
$F_z=1\text{ N}$	$A1$ and $A2$	displacement V (m)	$-1.72\ 10^{-3}$
		displacement W (m)	$5.42\ 10^{-3}$
$F_y=1\text{ N}$	$A1$ and $A2$	displacement V (m)	$1.75\ 10^{-3}$
		displacement W (m)	$-1.72\ 10^{-3}$

11 Modeling I

11.1 Characteristics of modeling

A modeling is used `DKT` (`QUAD4`). One tests in this modeling `COEF_RIGI_DRZ` negative. In this case, the `ddl DRZ` has a physical direction of "drilling rotation" or rotation around the normal.

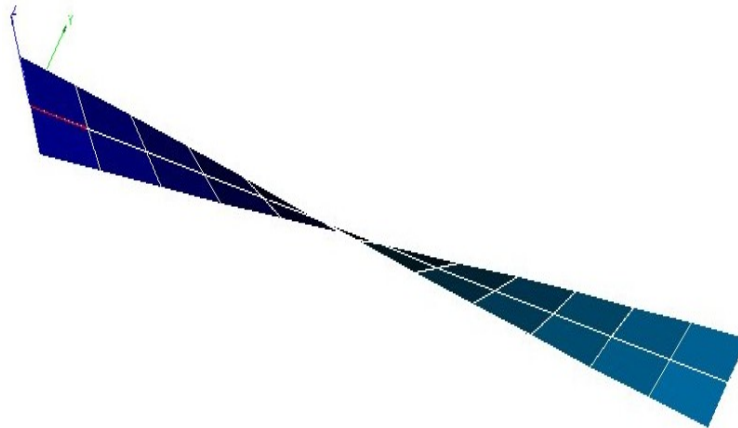

11.2 Characteristics of the grid

The grid contains 39 nodes and 24 meshes `QUAD4`.

11.3 Sizes tested and results

Loading (N)	Identification		Type of reference	Value of reference (m)	Tolerance (%)
	Not	Size			
$F_y=1$ $F_z=0$	A	DY	'SOURCE_EXTERNE'	$DY = 1.754 \times 10^{-3}$	48.0
$F_y=0$ $F_z=1$		DZ	'SOURCE_EXTERNE'	$DZ = 5.424 \times 10^{-3}$	62.5

11.4 Remarks

Under the effect of the great displacements undergone by the structure, the meshes `QUAD4` become increasingly left during calculation. Assumptions of modeling `DKT` then are not respected any more.

12 Modeling J

12.1 Characteristics of modeling

A modeling is used DKT (TRIA3).

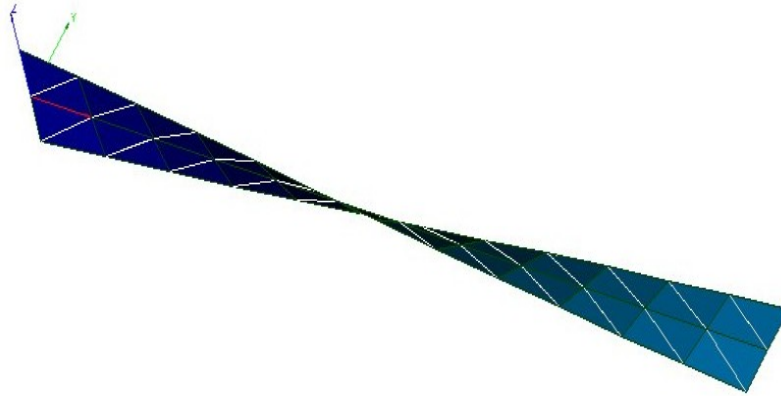

12.2 Characteristics of the grid

The grid contains 39 nodes and 48 meshes TRIA3.

12.3 Sizes tested and results

Loading (N)	Identification		Type of reference	Value of reference (m)	Tolerance (%)
	Not	Size			
$F_y=1$ $F_z=0$	A	DY	'SOURCE_EXTERNE'	$DY = 1.754 \times 10^{-3}$	17.0
$F_y=0$ $F_z=1$		DZ	'SOURCE_EXTERNE'	$DZ = 5.424 \times 10^{-3}$	2.5

13 Modeling K

13.1 Characteristics of modeling

A modeling is used `DST (QUAD4)`.

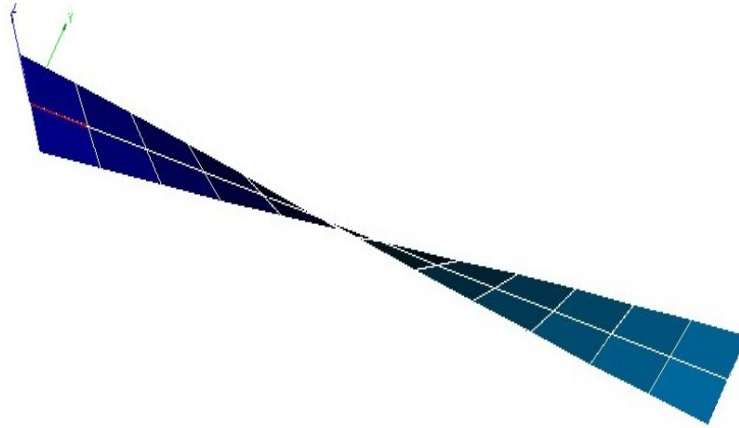

13.2 Characteristics of the grid

The grid contains 39 nodes and 24 meshes `QUAD4`.

13.3 Sizes tested and results

Loading (N)	Identification		Type of reference	Value of reference (m)	Tolerance (%)
	Not	Size			
$F_y=1$ $F_z=0$	A	DY	'SOURCE_EXTERNE'	$DY = 1.754 \times 10^{-3}$	48.0
$F_y=0$ $F_z=1$		DZ	'SOURCE_EXTERNE'	$DZ = 5.424 \times 10^{-3}$	62.5

13.4 Remarks

Under the effect of the great displacements undergone by the structure, the meshes `QUAD4` become increasingly left during calculation. Assumptions of modeling `DKT` then are not respected any more.

14 Modeling L

14.1 Characteristics of modeling

A modeling is used DST (TRIA3).

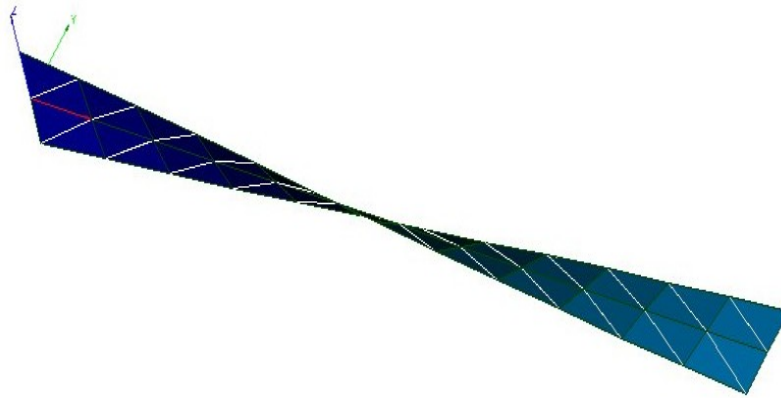

14.2 Characteristics of the grid

The grid contains 39 nodes and 48 meshes TRIA3.

14.3 Sizes tested and results

Loading (N)	Identification		Type of reference	Value of reference (m)	Tolerance (%)
	Not	Size			
$F_y=1$ $F_z=0$	A	DY	'SOURCE_EXTERNE'	$DY = 1.754 \times 10^{-3}$	15.0
$F_y=0$ $F_z=1$		DZ	'SOURCE_EXTERNE'	$DZ = 5.424 \times 10^{-3}$	1.5

15 Modeling M

15.1 Characteristics of modeling

A modeling is used Q4G (QUAD4).

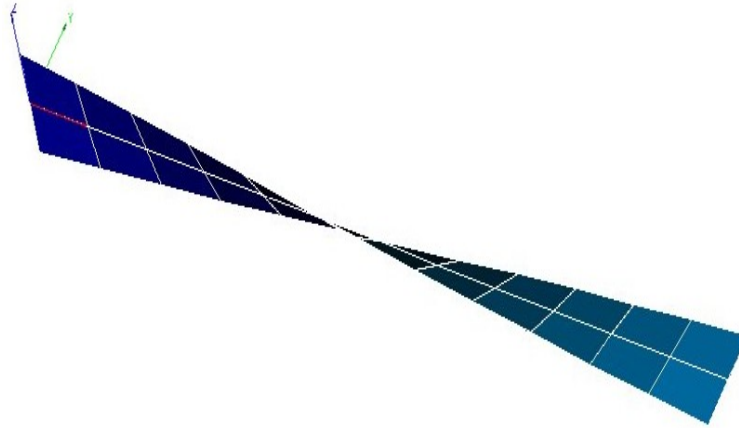

15.2 Characteristics of the grid

The grid contains 39 nodes and 24 meshes QUAD4.

15.3 Sizes tested and results

Loading (N)	Identification		Type of reference	Value of reference (m)	Tolerance (%)
	Not	Size			
$F_y=1$ $F_z=0$	A	DY	'SOURCE_EXTERNE'	$DY = 1.754 \times 10^{-3}$	48.0
$F_y=0$ $F_z=1$		DZ	'SOURCE_EXTERNE'	$DZ = 5.424 \times 10^{-3}$	62.5

15.4 Remarks

Under the effect of the great displacements undergone by the structure, the meshes QUAD4 become increasingly left during calculation. Assumptions of modeling DKT then are not respected any more.

16 Modeling NR

16.1 Characteristics of modeling

A modeling is used Q4G (TRIA3).

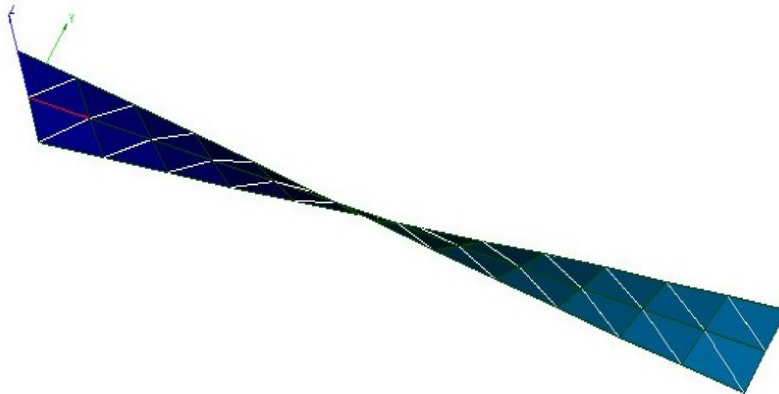

16.2 Characteristics of the grid

The grid contains 39 nodes and 48 meshes TRIA3.

16.3 Sizes tested and results

Loading (N)	Identification		Type of reference	Value of reference (m)	Tolerance (%)
	Not	Size			
$F_y=1$ $F_z=0$	A	DY	'SOURCE_EXTERNE'	$DY = 1.754 \times 10^{-3}$	11.0
$F_y=0$ $F_z=1$		DZ	'SOURCE_EXTERNE'	$DZ = 5.424 \times 10^{-3}$	6.0

17 Summary of the results

This test is very severe from the geometry of the hull which is left.

Elements `COQUE_3D` give very good performances (lower than 0.5%) with few nodes (modeling A and B).

For modelings `SHB`, elements `SHB8` give the same precision with a little more nodes (modeling D). They remain very good for a coarser grid (modeling C).

On the other hand, elements `SHB6` require a grid much finer to converge (modeling F). On a coarser grid (modeling E), the results are poor. Nevertheless these elements are very useful to be able to net an unspecified geometry with `SHB` linear.

Quadratic elements `SHB20` and `SHB15` good performances with few nodes give.

As regards modelings of the type plates (`DKT`, `DST`, `Q4G`), it is observed that the type of mesh used has a strong influence on the results:

- meshes `TRIA3` good performances (approximately 10 % of error) give, a finer grid improves moreover more appreciably the latter;
- meshes `QUAD4` on the other hand results very far away from the reference solution give. The formulation of the elements of plate makes the assumption of plane facets indeed, this one is not checked more on this test in the presence of great displacements.