

SSLS115 - Composite square plate under uniform pressure

Summary:

One treats the case of a square plate tri-layers, simply supported and subjected to a uniform pressure. The skins consist of an orthotropic homogeneous material, as well as the heart (same axes of orthotropism). Modules E and G heart are ten times weaker than those of the skins.

One calculates displacement in the center as well as the constraints with the lower and higher interfaces of skins.

The test gathers eight modelings: with regard to the four first, the got results are compared for triangular surface meshes then quadrangular, in two different reference marks user. Four last modelings make it possible to measure the sensitivity of the results the orientation of the triangular meshes in the two reference marks user.

1 Problem of reference

1.1 Geometry

Because of the geometrical and physical symmetry of the problem, only the quarter of the plate is modelled.

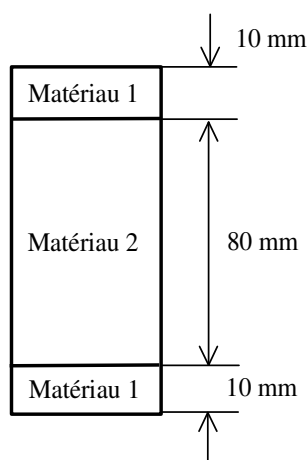
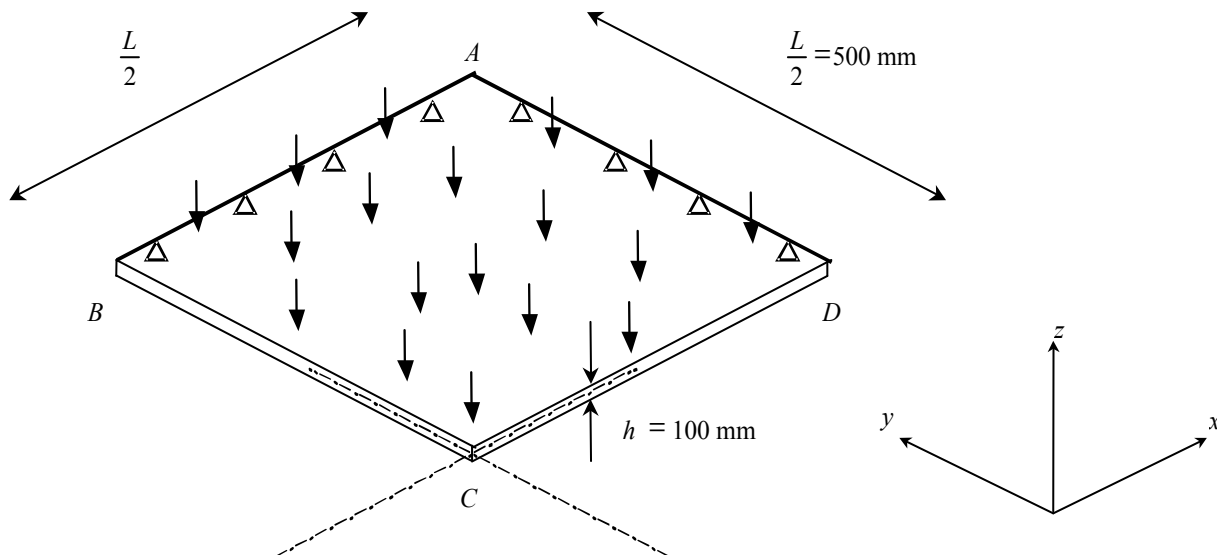

Twinge: $\frac{L}{h} = 10$: the plate is relatively thick.

1.2 Material properties

	Material 1	Material 2
$E_L (10^{11} N/m^2)$	3.4156	0.34156
$E_T (10^{11} N/m^2)$	1,793	0.1793
$G_{LN} (10^{11} N/m^2)$	0,608	0.0608
$G_{TN} (10^{11} N/m^2)$	1,015	0.1015
$G_{LT} (10^{11} N/m^2)$	1.0	0.1
NU_T	0.44	0.44

1.3 Boundary conditions and loadings

Simple bearing plate

Boundary conditions: AB : $DZ=0.$ $DRY=0.$
 AD : $DZ=0.$ $DRX=0.$
Symmetry BC : $DX=0.$ $DRY=0.$ $DRZ=0.$
 CD : $DY=0.$ $DRX=0.$ $DRZ=0.$

Loading:

FORCE_COQUE Uniform pressure $P=1\text{N}/\text{m}^2$

2 Reference solution

2.1 Reference solution

The digital solution obtained with a theory of plate multi-layer in orthotropic linear elasticity is given in the reference [bib1] page 341.

2.2 Results of reference

At the point C , following displacement is calculated z point as well as the constraints σ_x with the lower and higher interfaces of skins.

2.3 Uncertainty on the solution

Digital solution.

2.4 Bibliographical references

- 1) BATOZ and DHATT. Modeling of the structures by finite elements. Beams and plates. Hermes, 1990.

3 Modeling A

3.1 Characteristics of modeling

Element of hull DST (modeling of a quarter of plate).

The reference mark user is confused with the reference mark of orthotropism.

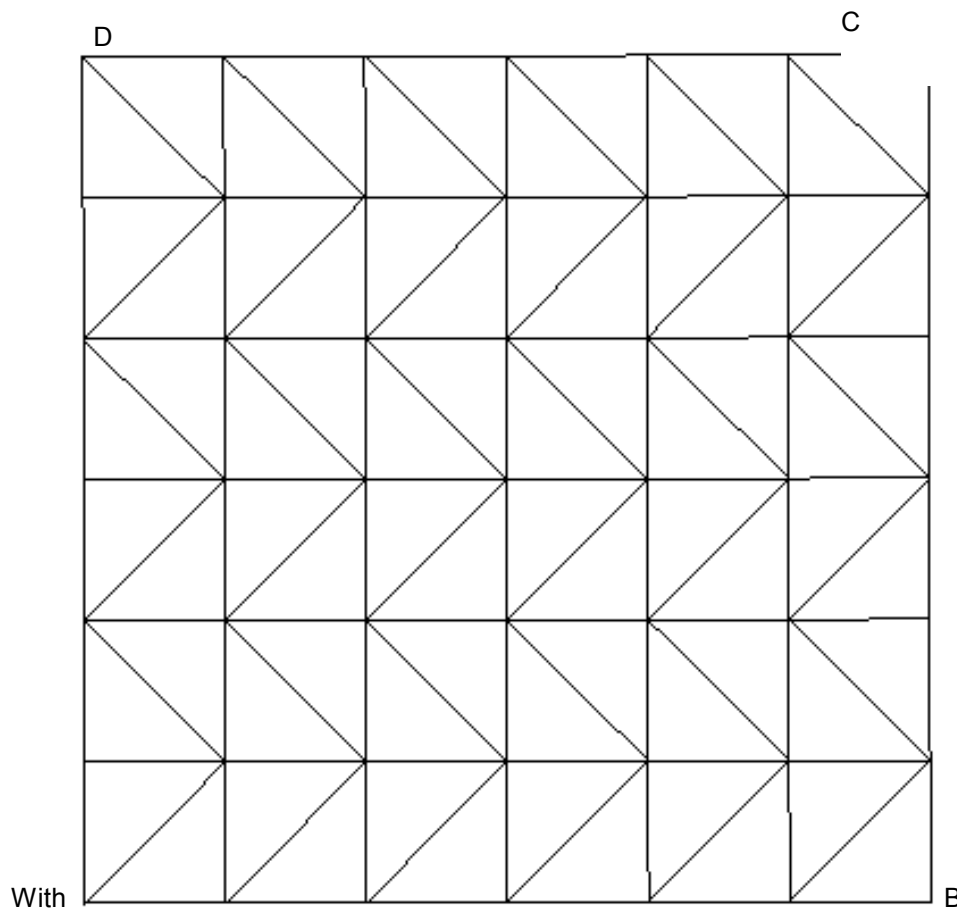

Limiting conditions: `DDL_IMPO`
`(GROUP_NO=' AB ', DZ=0., DRY=0.)`
`(GROUP_NO=' BC ', DX=0., DRY=0.)`
`(GROUP_NO=' CD ', DY=0., DRX=0.)`
`(GROUP_NO=' DA ', DZ=0., DRX=0.)`

Not C mesh: 72

3.2 Characteristics of the grid

Many nodes: 56

Many meshes and types: 72 TRIA3

3.3 Values tested

Not C	Identification	Reference	Aster	% Difference
	σ_x on lower layer 3	4.7100E+01	4.7662E+01	1,194

Constraints	σ_x on higher layer 3	5.8800E+01	5.9577E+01	1,323
	σ_x on lower layer 2	- 4.7100E+01	- 4.7662E+01	1,194
	σ_x on higher layer 2	4.7100E+01	4.7662E+01	1,194
	σ_x on lower layer 1	- 5.8800E+01	- 5.9577E+01	1,323
	σ_x on higher layer 1	-4.7100E+01	-4.7662E+01	1,194
	DX	0.0	0.0	0.0
Displacements	DY	0.0	0.0	0.0
	DZ	4.1920E+01	4.1851E+01	- 0,163

3.4 Contents of the file results

Values at the point of observation of displacements and constraints σ_x .

4 Modeling B

4.1 Characteristics of modeling

Element of hull `DST` (modeling of a quarter of plate).

The reference mark user is confused with the reference mark of orthotropism.

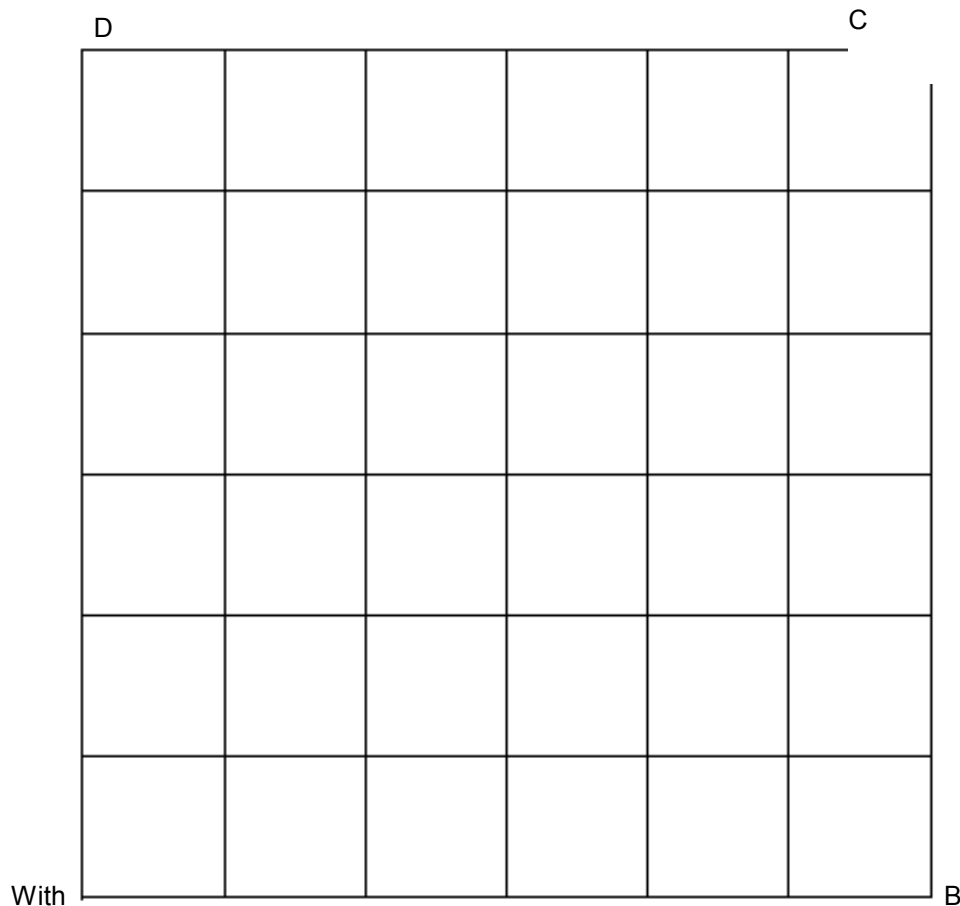

Conditions with limits:

```
DDL_IMPO
(GROUP_NO=' AB ', DZ=0.,
DRY=0.)
(GROUP_NO=' BC ', DX=0.,
DRY=0.)
(GROUP_NO=' CD ', DY=0.,
DRX=0.)
(GROUP_NO=' DA ', DZ=0.,
DRX=0.)
```

Not `C` mesh: 36

4.2 Characteristics of the grid

Many nodes: 57

Many meshes and types: 36 QUAD4

4.3 Values tested

Warning : The translation process used on this website is a "Machine Translation". It may be imprecise and inaccurate in whole or in part and is provided as a convenience.

Copyright 2019 EDF R&D - Licensed under the terms of the GNU FDL (<http://www.gnu.org/copyleft/fdl.html>)

Not C	Identification	Reference	Aster	% Difference
Constraints	σ_x on lower layer 3	4.7100E+01	5.0881E+01	8,028
	σ_x on higher layer 3	5.8800E+01	6.3601E+01	8,166
	σ_x on lower layer 2	-4.7100E+01	-5.0881E+01	8,028
	σ_x on higher layer 2	4.7100E+01	5.0881E+01	8,028
	σ_x on lower layer 1	-5.8800E+01	-6.3601E+01	8,166
	σ_x on higher layer 1	-4.7100E+01	-5.0881E+01	8,028
	DX		0.0	0.0
Displacements	DY	0.0	0.0	0.0
	DZ	4.1920E+01	4.2040E+01	0.29

4.4 Contents of the file results

Values at the point of observation of displacements and constraints σ_x .

5 Modeling C

5.1 Characteristics of modeling

Element of hull `DST` (modeling of a quarter of plate).

The model of plate associated with modeling A is turned of 20 degrees according to the nautical angle alpha and of 30 degrees according to beta.

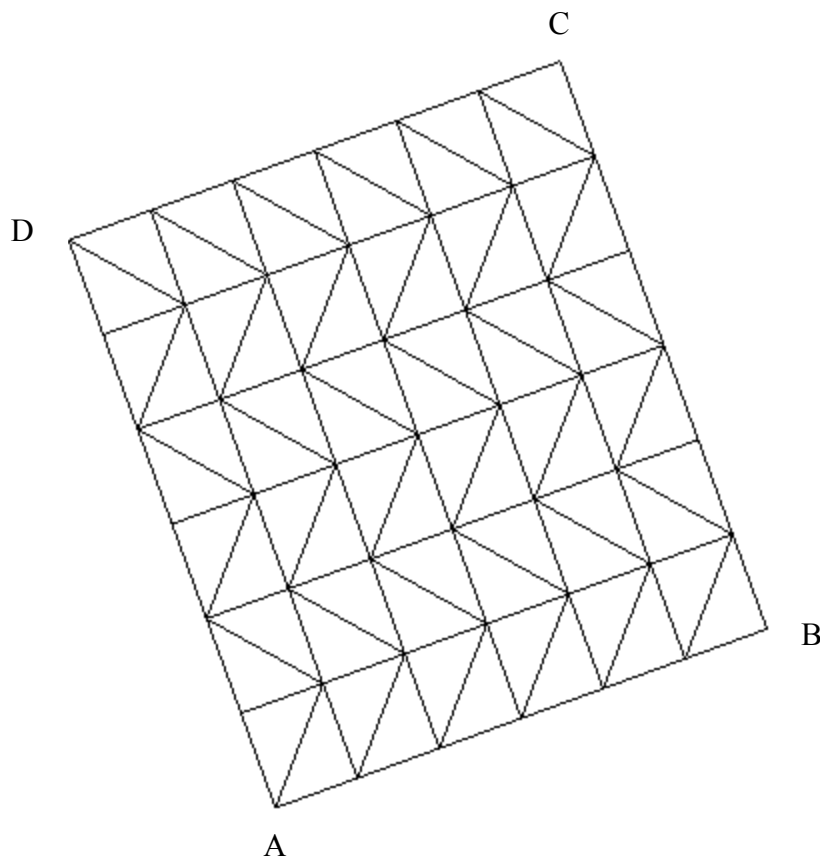

Conditions with limits: `LIAISON_OBLIQUE`
(`GROUP_NO=' AB'`, `ANGL_NAUT= (20. , 30. , 0.)`, `DZ=0.`,
`DRY=0.`)
(`GROUP_NO=' BC'`, `ANGL_NAUT= (20. , 30. , 0.)`, `DX=0.`,
`DRY=0.`)
(`GROUP_NO=' CD'`, `ANGL_NAUT= (20. , 30. , 0.)`, `DY=0.`,
`DRX=0.`)
(`GROUP_NO=' DA'`, `ANGL_NAUT= (20. , 30. , 0.)`, `DZ=0.`,
`DRX=0.`)

Not C mesh: 72

5.2 Characteristics of the grid

Many nodes: 56

Many meshes and types: 72 TRIA3

5.3 Values tested

Not C	Identification	Reference	Aster	% Difference
Constraints	σ_x on lower layer 3	4.7100E+01	4.7662E+01	1,194
	σ_x on higher layer 3	5.8800E+01	5.9577E+01	1,323
	σ_x on lower layer 2	-4.7100E+01	-4.7662E+01	1,194
	σ_x on higher layer 2	4.7100E+01	4.7662E+01	1,194
	σ_x on lower layer 1	-5.8800E+01	-5.9577E+01	1,323
	σ_x on higher layer 1	-4.7100E+01	-4.7662E+01	1,194
	DX		1.9696E+01	1.9663E+01
Displacements	DY	7.1687E+00	7.1570E+00	-0,162
	DZ	3.6304E+01	3.6244E+01	-0,163

5.4 Remarks

Values of reference of displacement to the point C are obtained by projecting the theoretical displacement established for a plate not turned in the new reference mark user (displacement for a not turned plate being vertical, new displacement is function of the projection of the axis Z). In the local reference mark, the projection of the axis Z is the following one:

$$\begin{bmatrix} \sin \beta \cos \alpha \\ \sin \beta \sin \alpha \\ \cos \beta \end{bmatrix}, \text{ with } \alpha = 20. \text{ and } \beta = 30.$$

5.5 Contents of the file results

Values at the point of observation of displacements and constraints σ_x .

6 Modeling D

6.1 Characteristics of modeling

Element of hull `DST` (modeling of a quarter of plate).

The model of plate associated with modeling B is turned of 20 degrees according to the nautical angle alpha and of 30 degrees according to beta.

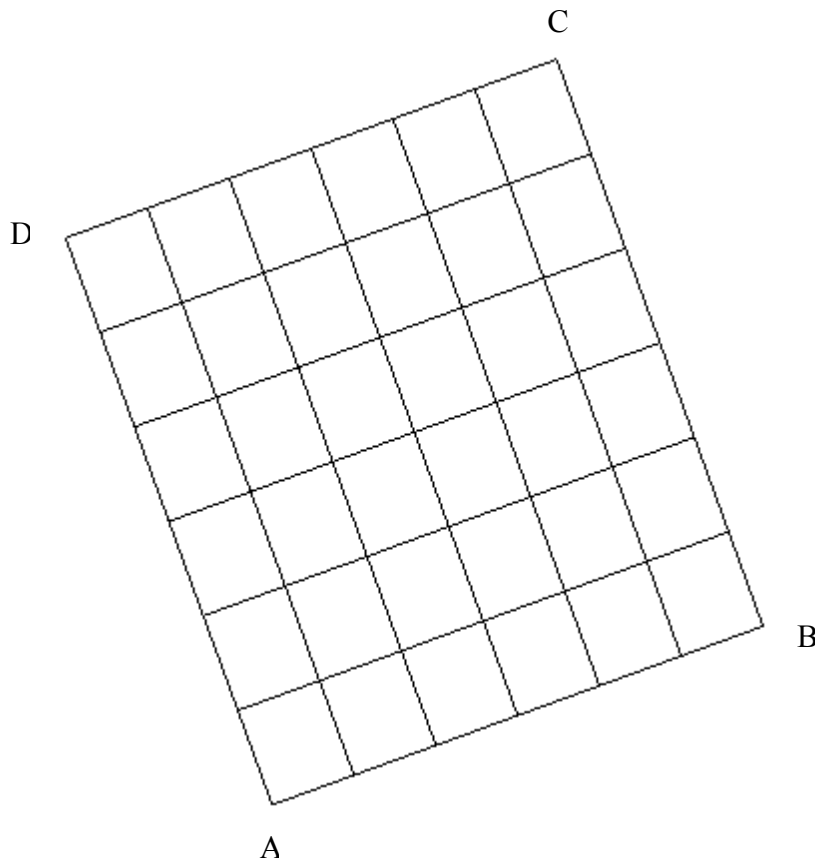

Conditions with limits:

```
LIAISON_OBLIQUE
(GROUP_NO=' AB', ANGL_NAUT= (20. , 30. , 0.), DZ=0.,
DRY=0.)
(GROUP_NO=' BC', ANGL_NAUT= (20. , 30. , 0.), DX=0.,
DRY=0.)
(GROUP_NO=' CD', ANGL_NAUT= (20. , 30. , 0.), DY=0.,
DRX=0.)
(GROUP_NO=' DA', ANGL_NAUT= (20. , 30. , 0.), DZ=0.,
DRX=0.)
```

Not C mesh: 36

6.2 Characteristics of the grid

Many nodes: 57

Many meshes and types: 36 QUAD4

6.3 Values tested

Not C	Identification	Reference	Aster	% Difference
Constraints	σ_x on lower layer 3	4.7100E+01	5.0881E+01	8,028
	σ_x on higher layer 3	5.8800E+01	6.3601E+01	8,166
	σ_x on lower layer 2	-4.7100E+01	-5.0881E+01	8,028
	σ_x on higher layer 2	4.7100E+01	5.0881E+01	8,028
	σ_x on lower layer 1	-5.8800E+01	-6.3601E+01	8,166
	σ_x on higher layer 1	-4.7100E+01	-5.0881E+01	8,028
	DX	1.9696E+01	1.9750E+01	0,290
	Displacements	DY	7.1687E+00	7.1895E+00
DZ		3.6304E+01	3.6409E+01	0,289

6.4 Remarks

Values of reference of displacement to the point C are obtained by projecting the theoretical displacement established for a plate not turned in the new reference mark user (displacement for a not turned plate being vertical, new displacement is function of the projection of the axis Z). In the local reference mark, the projection of the axis Z is the following one:

$$\begin{bmatrix} \sin \beta \cos \alpha \\ \sin \beta \sin \alpha \\ \cos \beta \end{bmatrix}, \text{ with } \alpha = 20. \text{ and } \beta = 30.$$

6.5 Contents of the file results

Values at the point of observation of displacements and constraints σ_x .

7 Modeling E

7.1 Characteristics of modeling

Element of hull `DST` (modeling of a quarter of plate).

The reference mark user is confused with the reference mark of orthotropism. Compared to modeling A, the model is characterized here by an orientation different from the surface meshes.

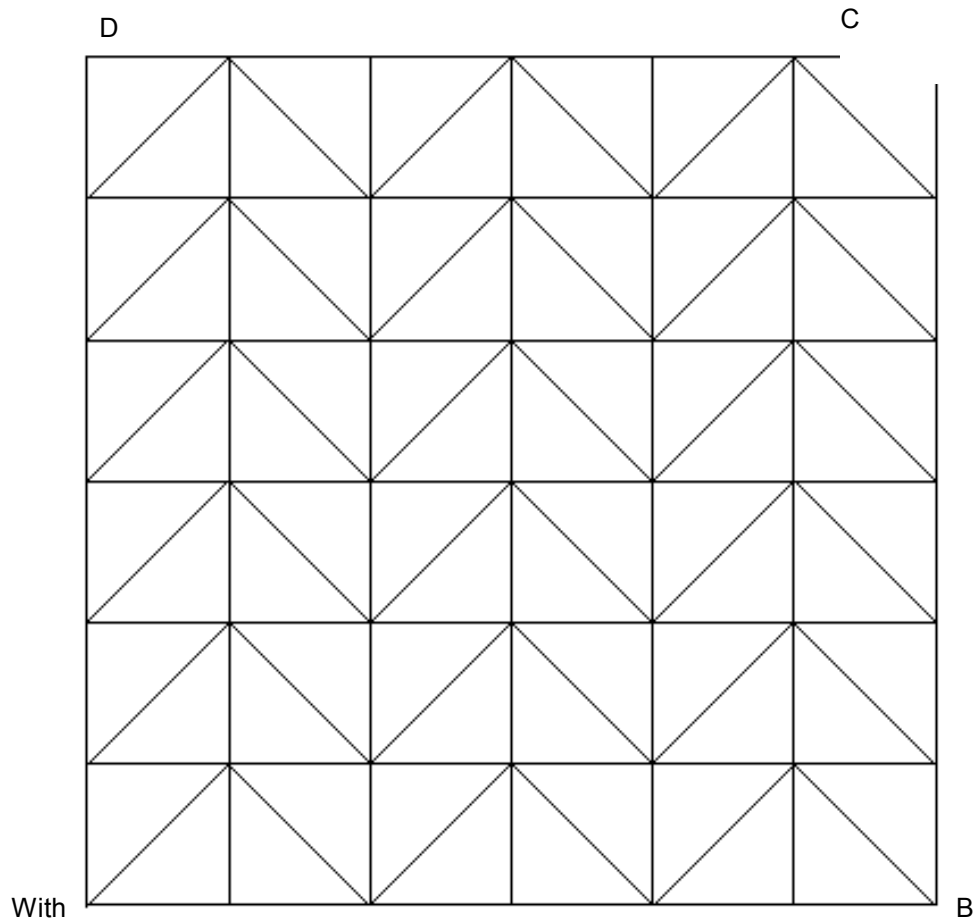

Conditions with limits:

<code>DDL_IMPO</code>		
<code>(GROUP_NO='</code>	<code>AB'</code>	<code>DZ=0.,</code>
<code>DRY=0.)</code>		
<code>(GROUP_NO='</code>	<code>BC'</code>	<code>DX=0.,</code>
<code>DRY=0.)</code>		
<code>(GROUP_NO='</code>	<code>CD'</code>	<code>DY=0.,</code>
<code>DRX=0.)</code>		
<code>(GROUP_NO='</code>	<code>DA'</code>	<code>DZ=0.,</code>
<code>DRX=0.)</code>		

Not `C` mesh: 72

7.2 Characteristics of the grid

Many nodes: 56

Many meshes and types: 72 TRIA3

7.3 Values tested

Not C	Identification	Reference	Aster	% Difference
Constraints	σ_x on lower layer 3	4.7100E+01	5.2430E+01	11,317
	σ_x on higher layer 3	5.8800E+01	6.5537E+01	11,459
	σ_x on lower layer 2	- 4.7100E+01	- 5.2430E+01	11,317
	σ_x on higher layer 2	4.7100E+01	5.2430E+01	11,317
	σ_x on lower layer 1	- 5.8800E+01	- 6.5537E+01	11,459
	σ_x on higher layer 1	-4.7100E+01	-5.2430E+01	11,317
	DX		0.0	0.0
Displacements	DY	0.0	0.0	0.0
	DZ	4.1920E+01	4.2024E+01	0,248

7.4 Contents of the file results

Values at the point of observation of displacements and constraints σ_x .

8 Modeling F

8.1 Characteristics of modeling

Element of hull `DST` (modeling of a quarter of plate).

The model of plate associated with modeling E is turned of 20 degrees according to the nautical angle alpha and of 30 degrees according to beta. Compared to modeling C, the model is characterized here by an orientation different from the meshes.

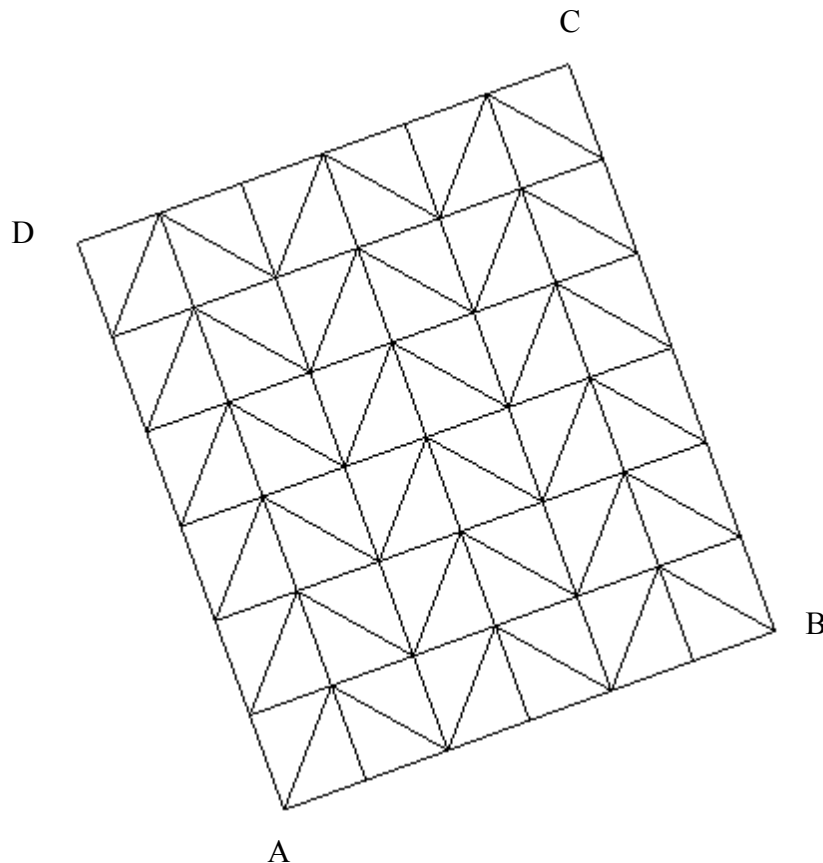

Conditions with limits: `LIAISON_OBLIQUE`
(`GROUP_NO=' AB'`, `ANGL_NAUT= (20. , 30. , 0.)`, `DZ=0.`,
`DRY=0.`)
(`GROUP_NO=' BC'`, `ANGL_NAUT= (20. , 30. , 0.)`, `DX=0.`,
`DRY=0.`)
(`GROUP_NO=' CD'`, `ANGL_NAUT= (20. , 30. , 0.)`, `DY=0.`,
`DRX=0.`)
(`GROUP_NO=' DA'`, `ANGL_NAUT= (20. , 30. , 0.)`, `DZ=0.`,
`DRX=0.`)

Not `C` mesh: 72

8.2 Characteristics of the grid

Many nodes: 56

Many meshes and types: 72 `TRIA3`

8.3 Values tested

Not C	Identification	Reference	Aster	% Difference
Constraints	σ_x on lower layer 3	4.7100E+01	5.2430E+01	11,317
	σ_x on higher layer 3	5.8800E+01	6.5537E+01	11,459
	σ_x on lower layer 2	- 4.7100E+01	- 5.2430E+01	11,317
	σ_x on higher layer 2	4.7100E+01	5.2430E+01	11,317
	σ_x on lower layer 1	- 5.8800E+01	- 6.5537E+01	11,459
	σ_x on higher layer 1	-4.7100E+01	-5.2430E+01	11,317
	DX		1.9696E+01	1.9744E+01
Displacements	DY	7.1687E+00	7.1865E+00	0,249
	DZ	3.6304E+01	3.6393E+01	0,248

8.4 Remarks

Values of reference of displacement to the point C are obtained by projecting the theoretical displacement established for a plate not turned in the new reference mark user (displacement for a not turned plate being vertical, new displacement is function of the projection of the axis Z). In the local reference mark, the projection of the axis Z is the following one:

$$\begin{bmatrix} \sin \beta \cos \alpha \\ \sin \beta \sin \alpha \\ \cos \beta \end{bmatrix}, \text{ with } \alpha = 20. \text{ and } \beta = 30.$$

8.5 Contents of the file results

Values at the point of observation of displacements and constraints σ_x .

9 Modeling G

9.1 Characteristics of modeling

Element of hull `DST` (modeling of a quarter of plate).

The model of plate is turned of 20 degrees according to the nautical angle α and of 30 degrees according to β , without reference to a model not turned.

The orientation of the meshes is here identical to that of the reference [bib1].

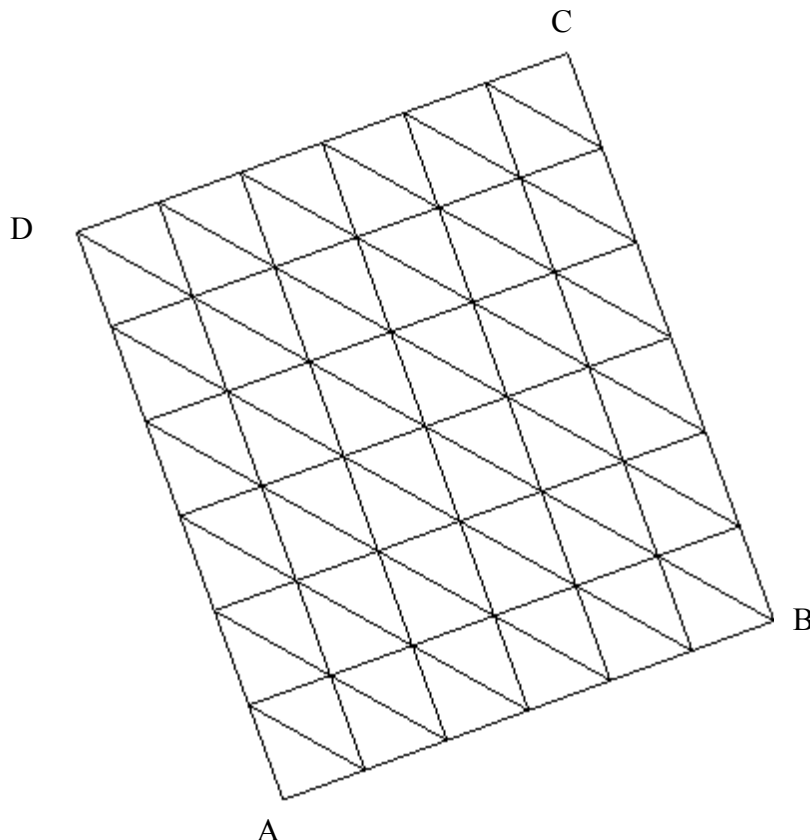

Limiting conditions: `LIAISON_OBLIQUE`
(GROUP_NO=' AB ', ANGL_NAUT= (20. , 30. , 0.), DZ=0.,
DRY=0.)
(GROUP_NO=' BC ', ANGL_NAUT= (20. , 30. , 0.), DX=0.,
DRY=0.)
(GROUP_NO=' CD ', ANGL_NAUT= (20. , 30. , 0.), DY=0.,
DRX=0.)
(GROUP_NO=' DA ', ANGL_NAUT= (20. , 30. , 0.), DZ=0.,
DRX=0.)

Not C mesh: 72

9.2 Characteristics of the grid

Many nodes: 56

Many meshes and types: 72 TRIA3

9.3 Values tested

Not C	Identification	Reference	Aster	% Difference
Constraints	σ_x on lower layer 3	4.7100E+01	4.7920E+01	1,742
	σ_x on higher layer 3	5.8800E+01	5.9900E+01	1,872
	σ_x on lower layer 2	-4.7100E+01	-4.7920E+01	1,742
	σ_x on higher layer 2	4.7100E+01	4.7920E+01	1,742
	σ_x on lower layer 1	-5.8800E+01	-5.9900E+01	1,872
	σ_x on higher layer 1	-4.7100E+01	-4.7920E+01	1,742
	DX	1.9696E+01	1.9882E+01	0,946
Displacements	DY	7.1687E+00	7.2365E+00	0,947
	DZ	3.6304E+01	3.6647E+01	0,946

9.4 Remarks

Values of reference of displacement to the point C are obtained by projecting the theoretical displacement established for a plate not turned in the new reference mark user (displacement for a not turned plate being vertical, new displacement is function of the projection of the axis Z). In the local reference mark, the projection of the axis Z is the following one:

$$\begin{bmatrix} \sin \beta \cos \alpha \\ \sin \beta \sin \alpha \\ \cos \beta \end{bmatrix}, \text{ with } \alpha = 20. \text{ and } \beta = 30.$$

9.5 Contents of the file results

Values at the point of observation of displacements and constraints σ_x .

10 Modeling H

10.1 Characteristics of modeling

Element of hull DST (modeling of a quarter of plate).

The model of plate is turned of 20 degrees according to the nautical angle alpha and of 30 degrees according to beta, without reference to a model not turned.

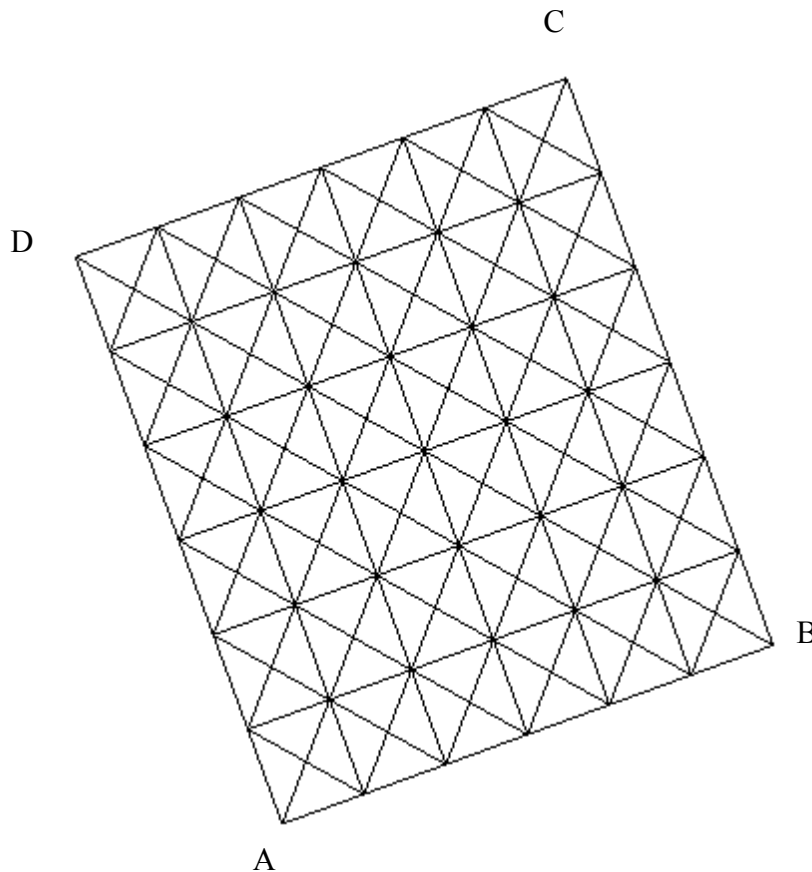

Limiting conditions: LIAISON_OBLIQUE
(GROUP_NO=' AB ', ANGL_NAUT= (20. , 30. , 0.), DZ=0.,
DRY=0.)
(GROUP_NO=' BC ', ANGL_NAUT= (20. , 30. , 0.), DX=0.,
DRY=0.)
(GROUP_NO=' CD ', ANGL_NAUT= (20. , 30. , 0.), DY=0.,
DRX=0.)
(GROUP_NO=' DA ', ANGL_NAUT= (20. , 30. , 0.), DZ=0.,
DRX=0.)

Not C mesh: 142

10.2 Characteristics of the grid

Many nodes: 101

Many meshes and types: 144 TRIA3

10.3 Values tested

Warning : The translation process used on this website is a "Machine Translation". It may be imprecise and inaccurate in whole or in part and is provided as a convenience.

Copyright 2019 EDF R&D - Licensed under the terms of the GNU FDL (<http://www.gnu.org/copyleft/fdl.html>)

Not C	Identification	Reference	Aster	% Difference
Constraints	σ_x on lower layer 3	4.7100E+01	5.0957E+01	8.19
	σ_x on higher layer 3	5.8800E+01	6.3691E+01	8.32
	σ_x on lower layer 2	-4.7100E+01	-5.0957E+01	8.19
	σ_x on higher layer 2	4.7100E+01	5.0957E+01	8.19
	σ_x on lower layer 1	-5.8800E+01	-6.3696E+01	8.32
	σ_x on higher layer 1	-4.7100E+01	-5.0957E+01	8.19
	DX		1.9696E+01	1.9735E+01
Displacements	DY	7.1687E+00	7.1830E+00	0,200
	DZ	3.6304E+01	3.6376E+01	0,200

10.4 Remarks

Values of reference of displacement to the point C are obtained by projecting the theoretical displacement established for a plate not turned in the new reference mark user (displacement for a not turned plate being vertical, new displacement is function of the projection of the axis Z). In the local reference mark, the projection of the axis Z is the following one:

$$\begin{bmatrix} \sin \beta \cos \alpha \\ \sin \beta \sin \alpha \\ \cos \beta \end{bmatrix}, \text{ with } \alpha = 20. \text{ and } \beta = 30.$$

10.5 Contents of the file results

Values at the point of observation of displacements and constraints σ_x .

11 Graphic synthesis

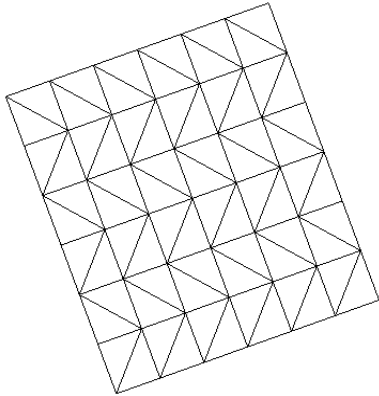

Modeling C

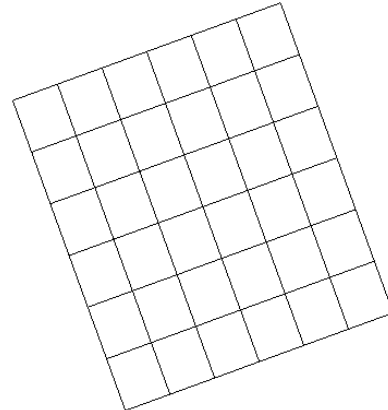

Modeling D

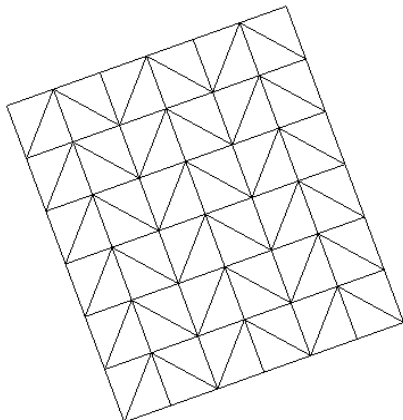

Modeling F

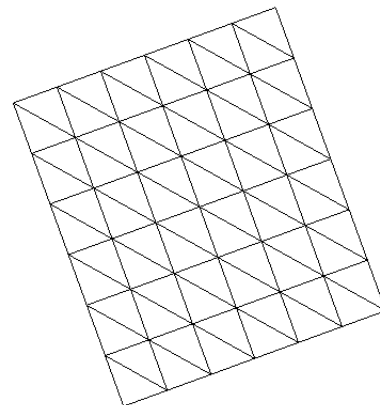

Modeling G

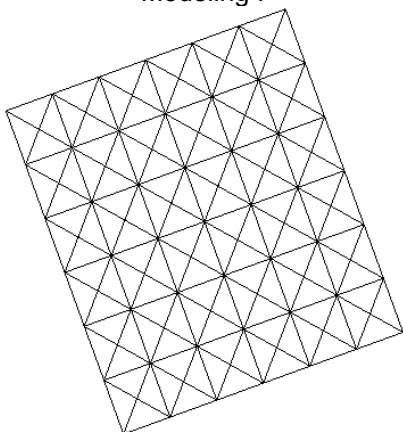

Modeling H

	% Forced	% Displacement
C	1.2	-0.17
D	8.1	0.23
F	11.4	0.25
G	1.8	0.95

Code_Aster

**Version
default**

Titre : SSLS115 - Plaque carrée composite sous pression un[...]
Responsable : DE SOZA Thomas

Date : 13/12/2011 Page : 21/22
Clé : V3.03.115 Révision :
131c2d759662

H 8.2 0.20

12 Summary of the results

The got results show that:

- With identical grid (standard of surface meshes and orientation of the meshes), the change of reference mark user does not influence the constraints;
- Because of orthotropism of the problem, there exists a considerable sensitivity to the orientation of the triangular surface meshes (the precision of calculations passes from 1 to 11% for the constraints and from 0.17 to 0.95% for displacements). This sensitivity does not disappear by refining the grid. This point is thus to take into account at the time of the comparison of the performances triangle/quadrangle.