

SSLV311 - Murakami 9.39. Crack in quarter of ellipse to the corner of a thick disc in rotation

Summary:

This test is resulting from the validation independent of the version in breaking process.

Scope of application:	Linear breaking process
Type of analysis:	Statics
Type of behavior:	Isotropic linear rubber band
Type of model:	Three-dimensional
Many modelings:	1
Objective:	Basic test into three-dimensional for isotropic elastic materials, in field limited in three directions, in the presence of a voluminal loading.
Explored parameters:	-
Fixed parameters:	Reports a/t , b/a , R_2/R_1 , t/R_1
Precision of the results:	Average standard deviation of 3% with the analytical reference solution

1 Problem of reference

1.1 Geometry

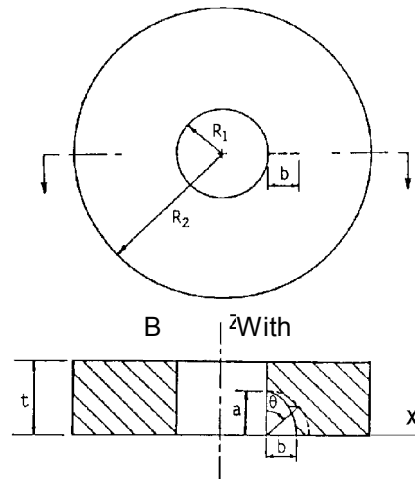

Internal ray:	$R_1 = 0,1 \text{ m}$
External ray:	$R_2 = 0,6 \text{ m}$
Thickness:	$t = 0,2 \text{ m}$
Half main roads:	$a = 0,05 \text{ m}$
Small half centers:	$b = 0,0125 \text{ m}$

1.2 Properties of material

Young modulus	$E = 2 \cdot 10^5 \text{ MPa}$
Poisson's ratio	$\nu = 0.3$
Density	$\rho = 7800 \text{ kg/m}^3$

1.3 Boundary conditions and loading

The model will be limited to the part of the thick disc located in the half space $Y \geq 0$, the plan of the vertical crack being a symmetry plane.

In the absence of nodes on the axis of revolution, a rigid mode will be blocked by a linear relation between degrees of freedom.

That is to say $A(R_1, 0, t)$ $B(-R_1, 0, t)$
points:

Blocking of the translation in X : $UX(A) + UX(B) = 0$

Blocking of the translation in Y : $UY = 0$ in the plan XOZ , except for the lips of the crack.

Blocking of the translation in Z : $UZ(A) = 0$

Blocking of rotation around OX : ensured by the boundary condition of symmetry in the plan XOZ

Blocking of rotation around OY : $UZ(B) = 0$

Blocking of rotation around OZ : ensured by the boundary condition of symmetry in the plan XOZ

Loading: stationary angular velocity $\omega = 500 \text{ rad/s}$

2 Reference solution

2.1 Method of calculating used for the reference solution

In [bib1], a reference solution is given, based on a method of integral equation of border. The value of the stress intensity factor in mode I am then:

$$K_I = \frac{3+\nu}{4} \cdot \rho \omega^2 \left(R_2^2 + \frac{1-\nu}{3+\nu} R_1^2 \right) \cdot \sqrt{\pi b} \cdot F_I$$

where the geometrical factor of correction is given, according to the parametric angle of the ellipse θ , with the figure below.

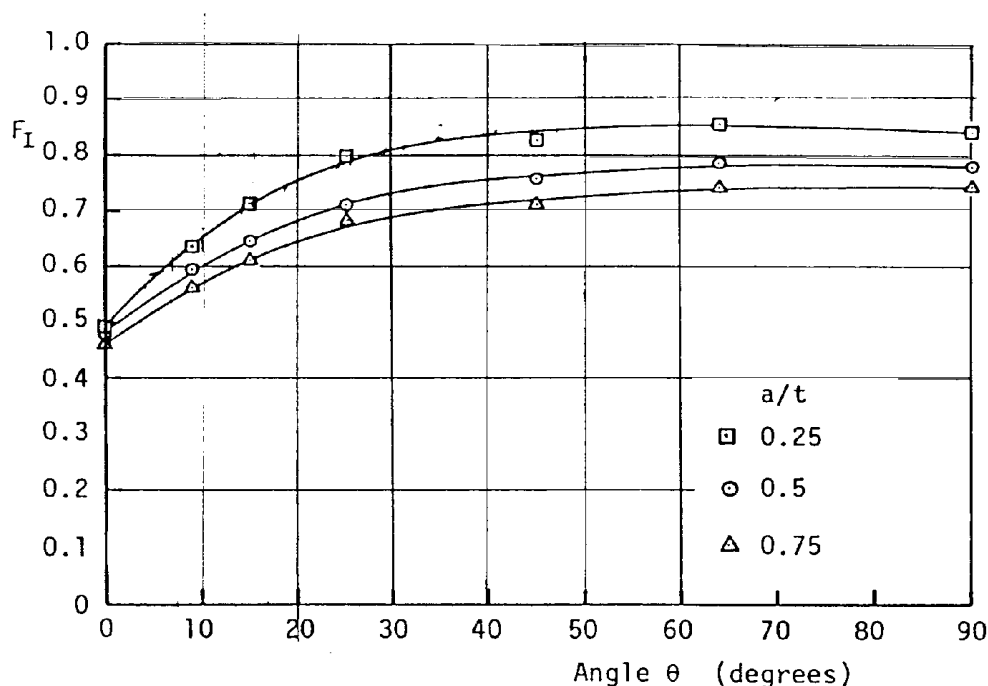

The report a/t chosen corresponds to the higher curve (squares).

The maximum change enters the marked points and the curve being of 2%, the misreading on the curve is lower than the announced maximum error (5%).

However, we do not use this reference because it seems erroneous.

We use as reference the digital results resulting from calculation with software ANSYS.

2.2 Uncertainty on the solution

2.3 Bibliographical references

- 1) Y. MURAKAMI: Stress Intensity Factors Handbook, box 9.39, pages 786-791. The Society of Materials Science, Japan, Pergamon Near, 1987.

3 Modeling A

3.1 Characteristics of modeling

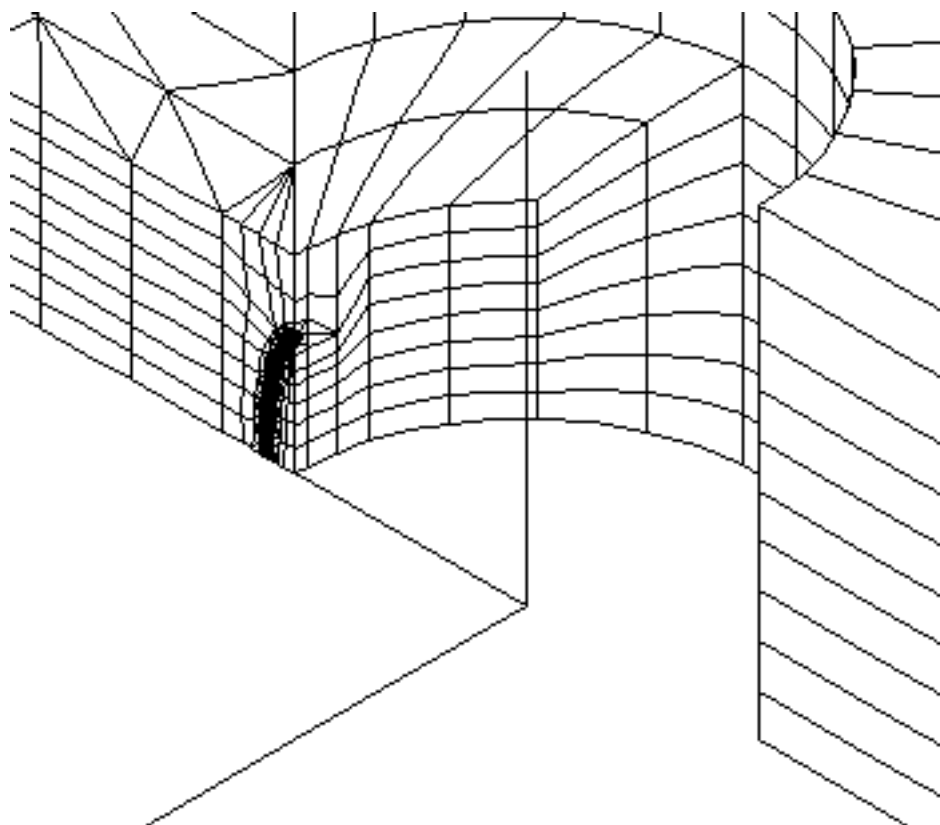
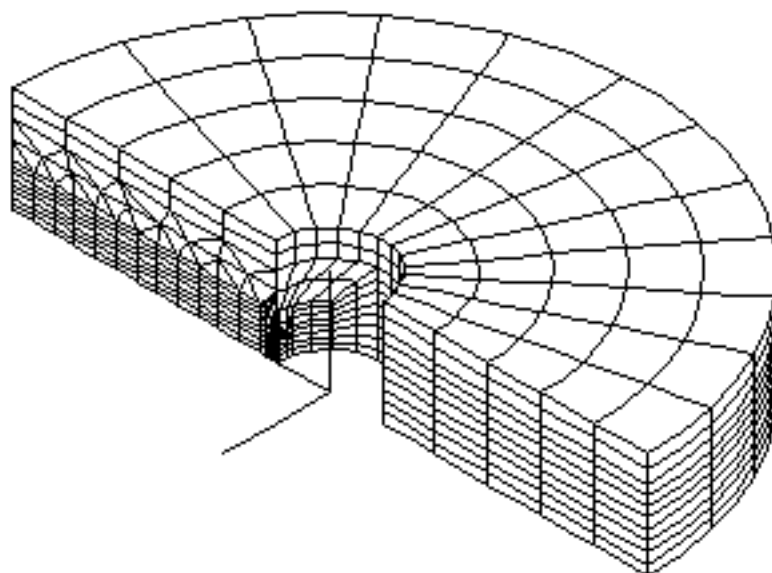

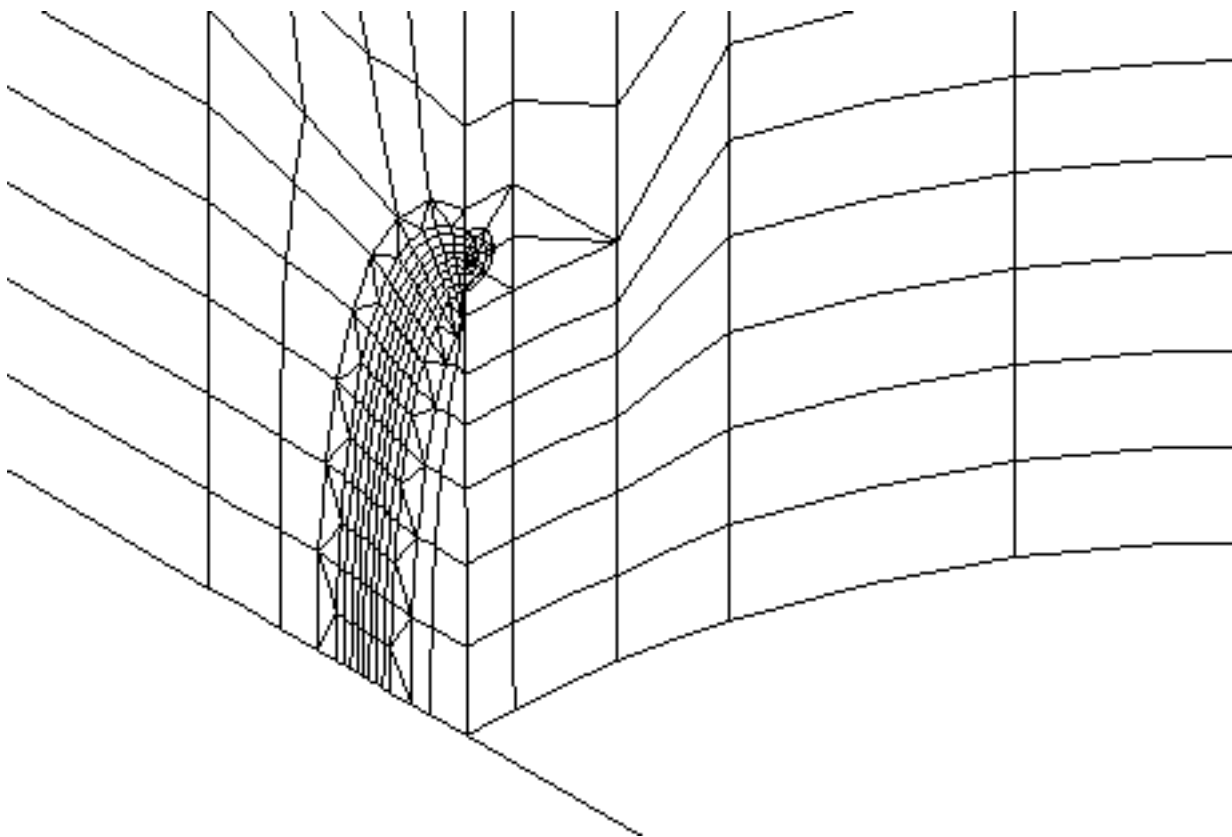

3.2 Characteristics of the grid

The initial grid consists of 8890 nodes and 2203 elements, including 1264 elements *CU20* and 939 elements *PR15*.

3.3 Features tested

Calculation of the factors of intensity of the constraints buildings, in all the nodes of the bottom of crack, by the method *THETA*.

The factors of intensity of the constraints buildings are calculated on a crown of lower ray $R_{inf} = 0,00075\text{ m}$ and of higher ray $R_{sup} = 0,0025\text{ m}$.

3.4 Values tested and results of modeling A

Identification	Reference ($\text{Pa} \cdot \sqrt{\text{m}}$)	Aster ($\text{Pa} \cdot \sqrt{\text{m}}$)	% difference
$K_{I, s} = 0$ (point 1)	6,09E+007	5,50E+007	9,7
$K_{I, s} = 5,34881\text{e-}3$ (point 8)	7,35E+007	7,44E+007	1,2
$K_{I, s} = 3,44482\text{e-}2$ (point 25)	1,02E+008	1,02E+008	0,1
$K_{I, s} = 5,36143\text{e-}2$ (point 33)	1,03E+008	9,70E+007	6,1

The average deviation is lower than 2%.

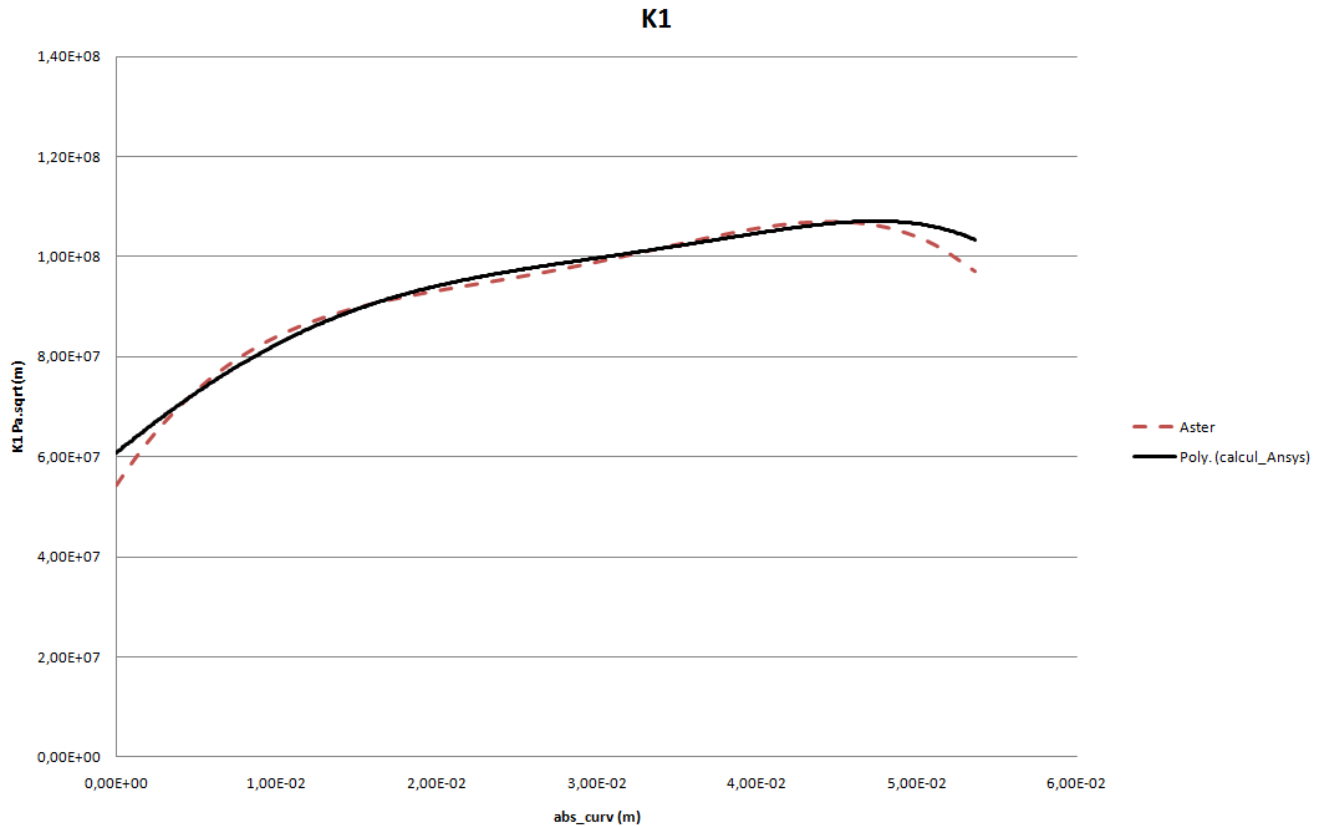

3.5 Values tested and results of modeling A with a linear grid and like Reference the Murakami solution

Identification	Reference (Pa. \sqrt{m})	Aster (Pa. \sqrt{m})	% difference
K_I , θ = 0 degrees	5,657E+07	5,789E+07	-2.33
K_I , θ = 1.4 degrees	5,945E+07	5,360E+07	9.84
K_I , θ = 2.8 degrees	6,292E+07	6,596E+07	-4.84
K_I , θ = 4.3 degrees	6,638E+07	6,606E+07	0.48
K_I , θ = 5.9 degrees	6,984E+07	6,902E+07	1.18
K_I , θ = 7.6 degrees	7,273E+07	7,289E+07	-0.22
K_I , θ = 9.5 degrees	7,562E+07	7,597E+07	-0.47
K_I , θ = 11.6 degrees	7,908E+07	8,053E+07	-1.83
K_I , θ = 14.4 degrees	8,197E+07	8,261E+07	-0.78
K_I , θ = 16.9 degrees	8,543E+07	8,695E+07	-1.78
K_I , θ = 20.5 degrees	8,889E+07	8,785E+07	1.17
K_I , θ = 25.1 degrees	9,178E+07	9,190E+07	-0.13
K_I , θ = 31.1 degrees	9,466E+07	9,173E+07	3.09
K_I , θ = 39.5 degrees	9,640E+07	9,562E+07	0.81
K_I , θ = 51.5 degrees	9,755E+07	9,510E+07	2.51

$K_I, \theta = 68.5$ degrees	9,755E+07	9,824E+07	-0.71
$K_I, \theta = 90$ degrees	9,640E+07	9,720E+07	-0.83

The parametric angles of the values tested correspond to the position of the 17 points of the bottom of crack. The figure below makes it possible to compare the result of calculation with the reference solution. The average standard deviation is very satisfactory:

$$\text{Average standard deviation} = \varepsilon = \sqrt{\frac{\int_{\Gamma} (K_I^{ref} - K_I^{aster})^2 ds}{\int_{\Gamma} (K_I^{ref})^2 ds}} = 3.11\%$$

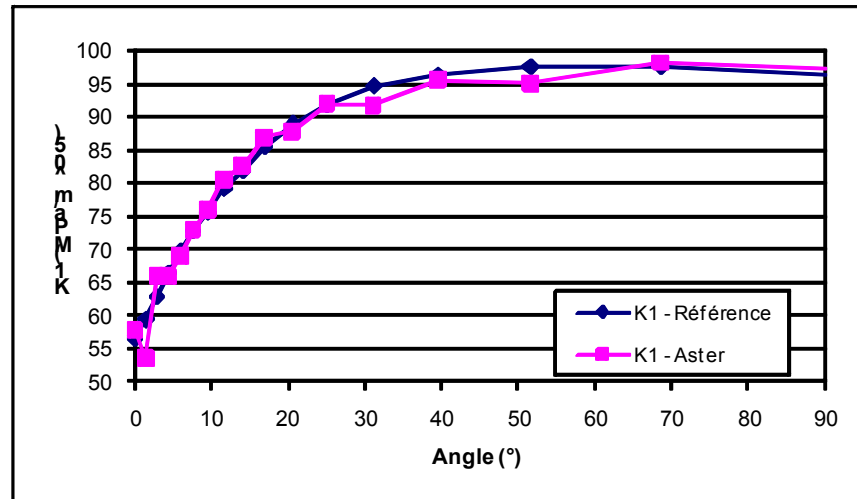

Note:

The voluminal loading is introduced here using the keyword `FORCE_INTERNE` (order `AFFE_CHAR_MECA`) and of `FORMULA`. The results are equivalent if the keyword is used `ROTATION`.

4 Summary of the results

Results provided by *Code_Aster* are satisfactory compared to those of ANSYS.
On the other hand, one does not understand why the variation is significant with the Murakami solution.