

---

## EPICU02 - Validation of the order POST\_K\_BETA in the case of UN defect elliptic with a positive shift

---

### Summary:

The order POST\_K\_BETA initially calculate the elastic stress intensity factor to the two points of the defect, using the constraints with the nodes resulting from the mechanical resolution In the second time, starting from this factor of elastic intensity of the constraints and by calling on the method known as of the "correction B ", the order POST\_K\_BETA determine the elastoplastic factor of intensity of the constraints on the level of these two points.

This test validates the estimate of the elastic factor of intensity of the constraints and of elastoplastic factor of intensity of the constraints to the two points of an elliptic defect under coating shifted in the base metal.

This test is composed of an axisymmetric modeling of the zone of heart tank.

## 1 Problem of reference

### 1.1 Geometry of the tank

The studied geometry is that of the zone of heart of a generic tank of the stage 900 MWe including one azimuth portion of 45° is schematized on the Figure 1.1-a.

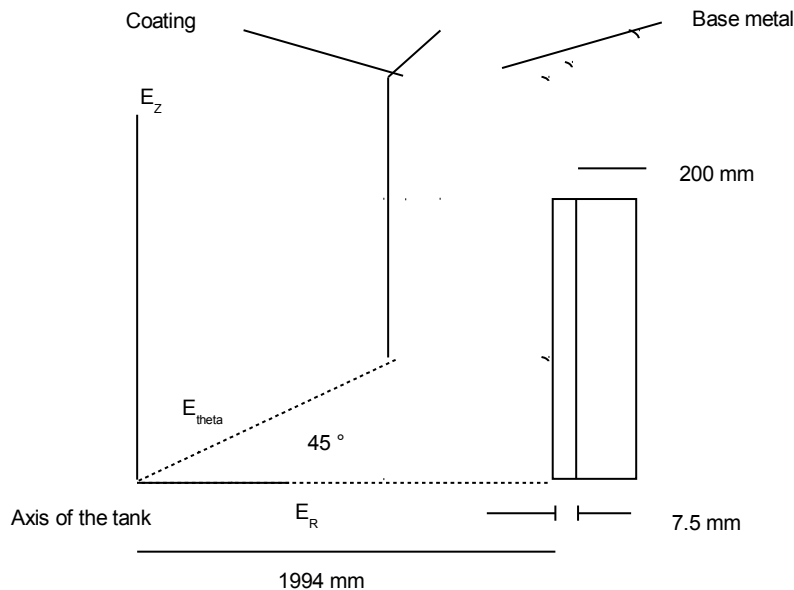

Figure 1.1-a: Sight of a section of 45° of the zone of heart of a generic tank of the stage 900 MWe

### 1.2 Characteristics of the defect considered

In the method  $K\beta$ , the defect is not modelled in the grid. The grid makes it possible to calculate the constraints with the nodes. The first postprocessing is initially applied to calculate the elastic factor of intensity of the constraints to the points of the defect starting from the constraints with the nodes (the method is detailed in [R7.02.10]). The second postprocessing is then applied to calculate the elastoplastic factor of intensity of the constraints using the method known as of the “correction B” (cf R7.02.10 documentation)].

For this test, the defect under coating considered is of elliptic form, of longitudinal orientation and it is shifted in the base metal. Its dimensions are the following ones (see figure which follows):

- Depth:  $prof_{def} = 6\text{mm}$
- Width:  $2b = 60\text{mm}$
- Several shifts in the base metal are considered:
  - $decalage = 0.0\text{mm}$
  - $decalage = 2.5\text{mm}$
  - $decalage = 5.0\text{mm}$
  - $decalage = 7.5\text{mm}$
  - $decalage = 10.0\text{mm}$

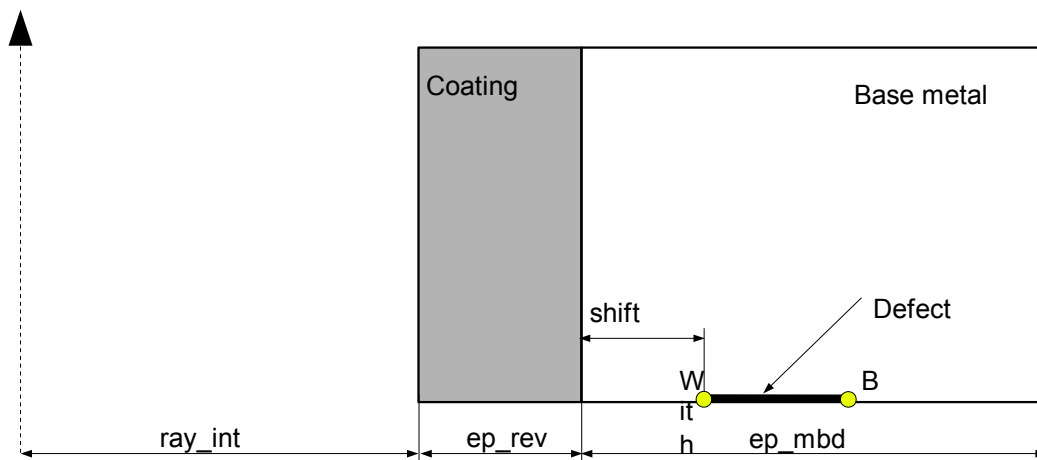

Figure 1.1-b: Position of the defect

## 1.3 Material properties

For calculation in thermics:

Two properties are indicated, it acts of:

- LAMBDA : thermal conductivity isotropic function of the temperature, expressed in  $W.m^{-1}.K^{-1}$ ,
- BETA : voluminal enthalpy according to the temperature, expressed in  $J.m^{-3}$ .

For the coating:

Temperature ( °C )	LAMBDA
0	14.7
20	14.7
50	15.2
100	15.8
150	16.7
200	17.2
250	18
300	18.6
350	19.3

Temperature ( °C )	BETA
0	0.000000.E+00
50	1.102100.E+08
100	3.013300.E+08
150	5.014300.E+08
200	7.081300.E+08
250	9.188800.E+08
300	1.132910.E+09
350	1.348980.E+09

For the base metal:

Temperature ( °C )	LAMBDA
0	37.7
20	37.7
50	38.6
100	39.9
150	40.5
200	40.5
250	40.2
300	39.5
350	38.7

Temperature ( °C )	BETA
0	0.000000.E+00
50	1.061900.E+08
100	2.903300.E+08
150	4.829100.E+08
200	6.832800.E+08
250	8.921600.E+08
300	1.109440.E+09
350	1.335060.E+09

For calculation in mechanics:

Four parameters are indicated, it acts of:

- $E$  : Young modulus, expressed in  $Pa$ ,
- $\nu=0.3$  Poisson's ratio,
- ALPHA: isotropic thermal dilation coefficient, expressed in  $^{\circ}C$ ,
- TEMP\_DEF\_ALPHA= 20 value of the temperature to which values of the thermal dilation coefficient ALPHA were determined, expressed in  $^{\circ}C$ .
- VALE\_REF = 287 $^{\circ}$  Temperature of reference  $T_{Ref}$ , for which the thermal deformation of origin worthless, is expressed in  $^{\circ}C$ .

For the coating:

Temperature ( °C )	E
0	1.985E+11
20	1.97E+11
50	1.95E+11
100	1.915E+11
150	1.875E+11
200	1.84E+11
250	1.8E+11
300	1.765E+11
350	1.72E+11

Temperature ( °C )	ALPHA
0	1.64E-05
20	1.64E-05
50	1.654E-05
100	1.68E-05
150	1.704E-05
200	1.72E-05
250	1.75E-05
300	1.777E-05
350	

For the base metal:

Temperature ( °C )	E
0	2.05E+11
20	2.04E+11
50	2.03E+11
100	2E+11
150	1.97E+11
200	1.93E+11
250	1.89E+11
300	1.85E+11
350	1.8E+11

Temperature ( °C )	ALPHA
0	1.122E-05
20	1.122E-05
50	1.145E-05
100	1.179E-05
150	1.214E-05
200	1.247E-05
250	1.278E-05
300	1.308E-05

## 1.4 Boundary conditions and loadings

### 1.4.1 Stage 1: non-linear thermal calculation

The limiting conditions applied to thermal calculation are summarized on the Figure 1.3-a and break up as follows:

- fluid temperature and coefficient of exchange imposed in internal wall,
- thermal isolation in external wall.

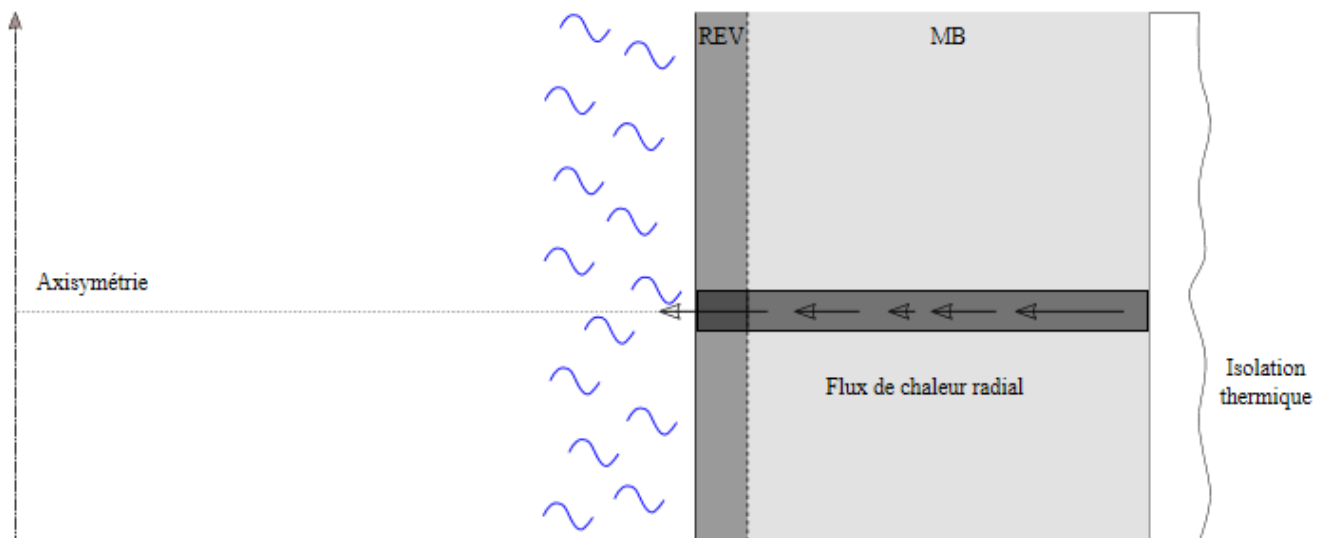

Figure 1.3-a: Thermal problem considered

### 1.4.2 Stage 2: mechanical calculation in linear elasticity

Warning : The translation process used on this website is a "Machine Translation". It may be imprecise and inaccurate in whole or in part and is provided as a convenience.

Copyright 2019 EDF R&D - Licensed under the terms of the GNU FDL (<http://www.gnu.org/copyleft/fdl.html>)

The limiting conditions of the mechanical problem are summarized on the Figure 1.3-b below and break up as follows:

- fluid pressure in internal wall,
- symmetry according to axis OZ on the lower segment,
- basic effect like uniform displacement according to axis OZ on the higher segment.

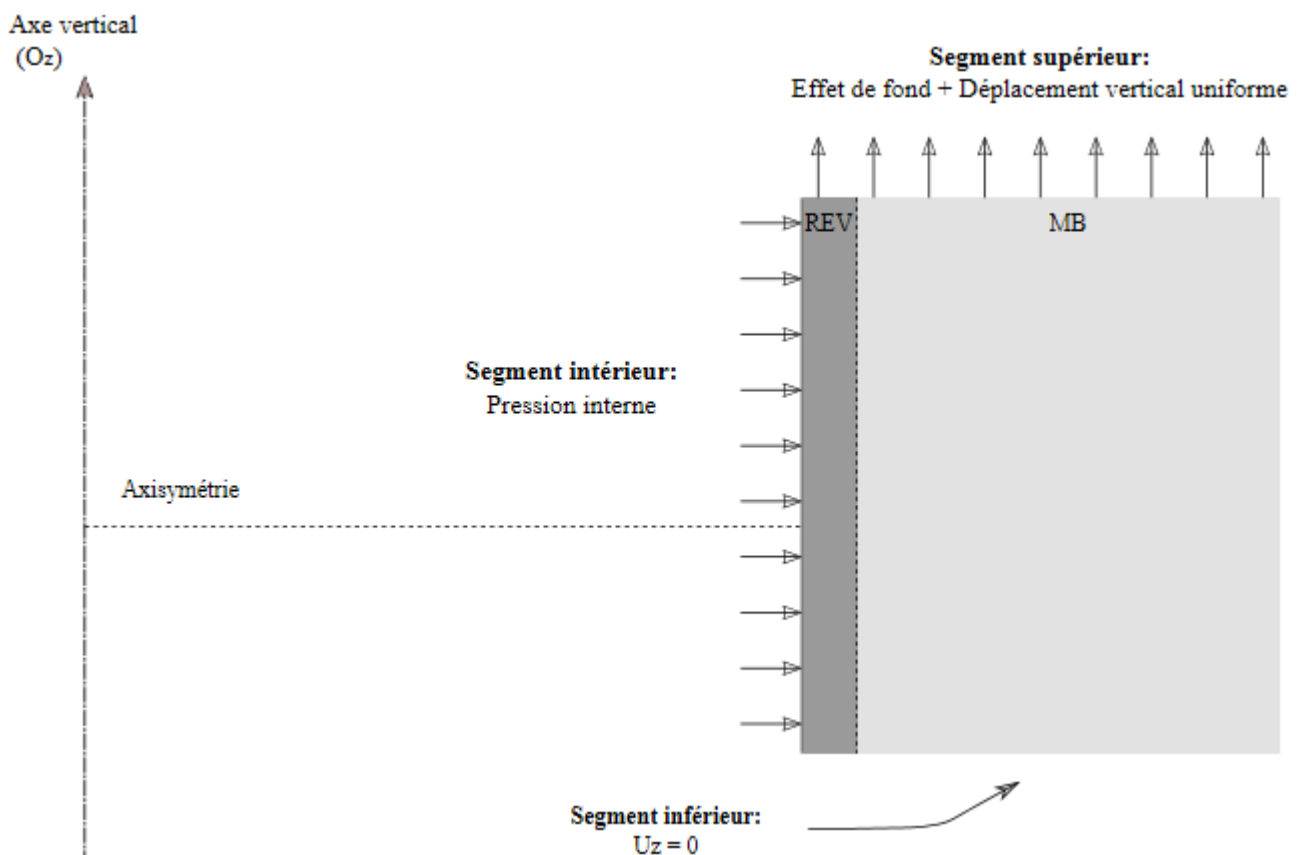

Figure 1.3-b: Mechanical problem considered

## 2 Reference solution

### 2.1 Sizes and results of reference

The checked sizes, with the points A (with dimensions coating) and B (with dimensions base metal) of the defect are the following ones:

- The elastic stress intensity factor,
- The stress intensity factor corrected plastically.

The results of reference are those resulting from the base of tests of code CUVE1D.

These calculations carried out with CUVE1D are detailed in the note of validation of this software: "CUVE1D Version 2 - Note of validation" H-T26-2007-00833-FR.

### 2.2 Uncertainty on the solution

Uncertainties on the reference solution are estimated at 2% .

## 3 Modeling A

### 3.1 Characteristics of modeling

Modeling 2D , axisymetic (SEG3, QUAD8)

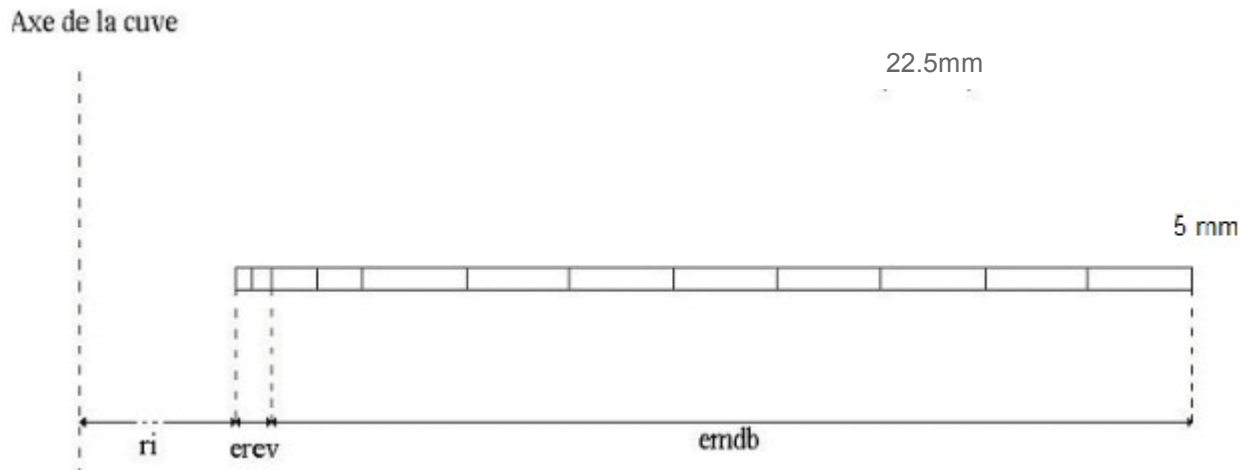

### 3.2 Characteristics of the grid

Many nodes: 63  
Many elements: 26 SEG3, 12 QUAD8.

### 3.3 Sizes tested and results

Below the comparison of the results *Aster* compared to the results of reference resulting from the computer code CUVE1D in version 2.1:

Shift = 0.mm

Type of value	Moment (S)	Type of Reference	Reference (Mpa)	% Tolerance
K1_REV	0	'SOURCE_EXTERNE'	1.5349	0.1
KCP_REV	0	'SOURCE_EXTERNE'	1.8363	0.5
TEMPPF_REV	0	'SOURCE_EXTERNE'	287.0	0.1
K1_MDB	0	'SOURCE_EXTERNE'	1,522	1.0
KCP_MDB	0	'SOURCE_EXTERNE'	2.0203	1.0
TEMPPF_MDB	0	'SOURCE_EXTERNE'	287.0	0.1
K1_REV	210	'SOURCE_EXTERNE'	4.8435	1.5
KCP_REV	210	'SOURCE_EXTERNE'	6.2753	1.5
TEMPPF_REV	210	'SOURCE_EXTERNE'	105.19	1.5
K1_MDB	210	'SOURCE_EXTERNE'	4.4915	1.5
KCP_MDB	210	'SOURCE_EXTERNE'	6.7053	1.5
TEMPPF_MDB	210	'SOURCE_EXTERNE'	105.19	18.0
K1_REV	3871	'SOURCE_EXTERNE'	3,724	0.5
KCP_REV	3871	'SOURCE_EXTERNE'	1.8043	1.0
TEMPPF_REV	3871	'SOURCE_EXTERNE'	84.98	0.5
K1_MDB	3871	'SOURCE_EXTERNE'	3,506	1.0
KCP_MDB	3871	'SOURCE_EXTERNE'	2.5675	1.5

Warning : The translation process used on this website is a "Machine Translation". It may be imprecise and inaccurate in whole or in part and is provided as a convenience.

Copyright 2019 EDF R&D - Licensed under the terms of the GNU FDL (<http://www.gnu.org/copyleft/fdl.html>)



TEMPFF_MDB	3871	`SOURCE_EXTERNE'	84.98	1.6
------------	------	------------------	-------	-----

**Shift = 2,5mm**

Type of value	Moment (S)	Type of Reference	Reference (Mpa)	% Tolerance
K1_REV	0	`SOURCE_EXTERNE'	1.5192	0.1
KCP_REV	0	`SOURCE_EXTERNE'	1.7565	4.0
TEMPFF_REV	0	`SOURCE_EXTERNE'	287.0	0.1
K1_MDB	0	`SOURCE_EXTERNE'	1.5105	0.1
KCP_MDB	0	`SOURCE_EXTERNE'	1.9039	5.5
TEMPFF_MDB	0	`SOURCE_EXTERNE'	287.0	0.1
K1_REV	210	`SOURCE_EXTERNE'	4.5346	1.5
KCP_REV	210	`SOURCE_EXTERNE'	5.8735	1.5
TEMPFF_REV	210	`SOURCE_EXTERNE'	112.4	1.5
K1_MDB	210	`SOURCE_EXTERNE'	4.2037	1.5
KCP_MDB	210	`SOURCE_EXTERNE'	6.2731	1.5
TEMPFF_MDB	210	`SOURCE_EXTERNE'	129.23	1.5
K1_REV	3871	`SOURCE_EXTERNE'	3,531	0.5
KCP_REV	3871	`SOURCE_EXTERNE'	1,693	1.0
TEMPFF_REV	3871	`SOURCE_EXTERNE'	85.44	0.5
K1_MDB	3871	`SOURCE_EXTERNE'	3,531	6.0
KCP_MDB	3871	`SOURCE_EXTERNE'	2.4172	1.0
TEMPFF_MDB	3871	`SOURCE_EXTERNE'	86.54	0.5

**Shift = 5.0mm**

Type of value	Moment (S)	Type of Reference	Reference (Mpa)	% Tolerance
K1_REV	0	`SOURCE_EXTERNE'	1.5105	0.1
KCP_REV	0	`SOURCE_EXTERNE'	1.7044	6.0
TEMPFF_REV	0	`SOURCE_EXTERNE'	287.0	0.1
K1_MDB	0	`SOURCE_EXTERNE'	1.5028	0.1
KCP_MDB	0	`SOURCE_EXTERNE'	1.8244	9.0
TEMPFF_MDB	0	`SOURCE_EXTERNE'	287.0	0.1
K1_REV	210	`SOURCE_EXTERNE'	4.2543	1.5
KCP_REV	210	`SOURCE_EXTERNE'	5,499	1.0
TEMPFF_REV	210	`SOURCE_EXTERNE'	119.5	1.5
K1_MDB	210	`SOURCE_EXTERNE'	3.9338	1.5
KCP_MDB	210	`SOURCE_EXTERNE'	5.8529	1.5
TEMPFF_MDB	210	`SOURCE_EXTERNE'	136.03	1.5
K1_REV	3871	`SOURCE_EXTERNE'	3,357	0.5
KCP_REV	3871	`SOURCE_EXTERNE'	1.5872	0.2
TEMPFF_REV	3871	`SOURCE_EXTERNE'	85.9	0.5
K1_MDB	3871	`SOURCE_EXTERNE'	3,156	0.5
KCP_MDB	3871	`SOURCE_EXTERNE'	2.2645	0.1
TEMPFF_MDB	3871	`SOURCE_EXTERNE'	86.99	0.5

Shift = 7.5mm

Type of value	Moment (S)	Type of Reference	Reference (Mpa)	% Tolerance
K1_REV	0	'SOURCE_EXTERNE'	1.5049	0.1
KCP_REV	0	'SOURCE_EXTERNE'	1,668	8.5
TEMPPF_REV	0	'SOURCE_EXTERNE'	287.0	0.1
K1_MDB	0	'SOURCE_EXTERNE'	1.4972	0.1
KCP_MDB	0	'SOURCE_EXTERNE'	1.7679	12.5
TEMPFF_MDB	0	'SOURCE_EXTERNE'	287.0	0.1
K1_REV	210	'SOURCE_EXTERNE'	3.9887	1.5
KCP_REV	210	'SOURCE_EXTERNE'	5.1214	0.5
TEMPPF_REV	210	'SOURCE_EXTERNE'	126.48	1.5
K1_MDB	210	'SOURCE_EXTERNE'	3.6757	1.5
KCP_MDB	210	'SOURCE_EXTERNE'	5.4159	0.1
TEMPFF_MDB	210	'SOURCE_EXTERNE'	142.69	1.5
K1_REV	3871	'SOURCE_EXTERNE'	3,191	6.0
KCP_REV	3871	'SOURCE_EXTERNE'	1,469	4.0
TEMPPF_REV	3871	'SOURCE_EXTERNE'	86.35	1.0
K1_MDB	3871	'SOURCE_EXTERNE'	2,993	6.0
KCP_MDB	3871	'SOURCE_EXTERNE'	2.0853	3.5
TEMPFF_MDB	3871	'SOURCE_EXTERNE'	87.44	1.0

Shift = 10,0mm

Type of value	Moment (S)	Type of Reference	Reference (Mpa)	% Tolerance
K1_REV	0	'SOURCE_EXTERNE'	1.5007	0.1
KCP_REV	0	'SOURCE_EXTERNE'	1.6411	9.5
TEMPPF_REV	0	'SOURCE_EXTERNE'	287.0	0.1
K1_MDB	0	'SOURCE_EXTERNE'	1.4928	0.1
KCP_MDB	0	'SOURCE_EXTERNE'	1.7258	14.0
TEMPFF_MDB	0	'SOURCE_EXTERNE'	287.0	0.1
K1_REV	210	'SOURCE_EXTERNE'	3.7326	1.5
KCP_REV	210	'SOURCE_EXTERNE'	4.7283	1.0
TEMPPF_REV	210	'SOURCE_EXTERNE'	133.33	1.5
K1_MDB	210	'SOURCE_EXTERNE'	3.4263	1.5
KCP_MDB	210	'SOURCE_EXTERNE'	4.9503	2.0
TEMPFF_MDB	210	'SOURCE_EXTERNE'	149.21	1.5
K1_REV	3871	'SOURCE_EXTERNE'	3.03	0.2
KCP_REV	3871	'SOURCE_EXTERNE'	1.3289	8.0
TEMPPF_REV	3871	'SOURCE_EXTERNE'	86.81	0.5
K1_MDB	3871	'SOURCE_EXTERNE'	2,834	0.5
KCP_MDB	3871	'SOURCE_EXTERNE'	1.8787	8.0

---

TEMPFF_MDB	3871	'SOURCE_EXTERNE'	87.89	0.5
------------	------	------------------	-------	-----

---

On the following figures are represented the evolutions of the elastic stress intensity factor and of the factor of intensity of the constraints corrected plastically with point A (REV) and the point B (MDB) of the defect obtained with Code\_Aster. These evolutions are compared with the reference solution.

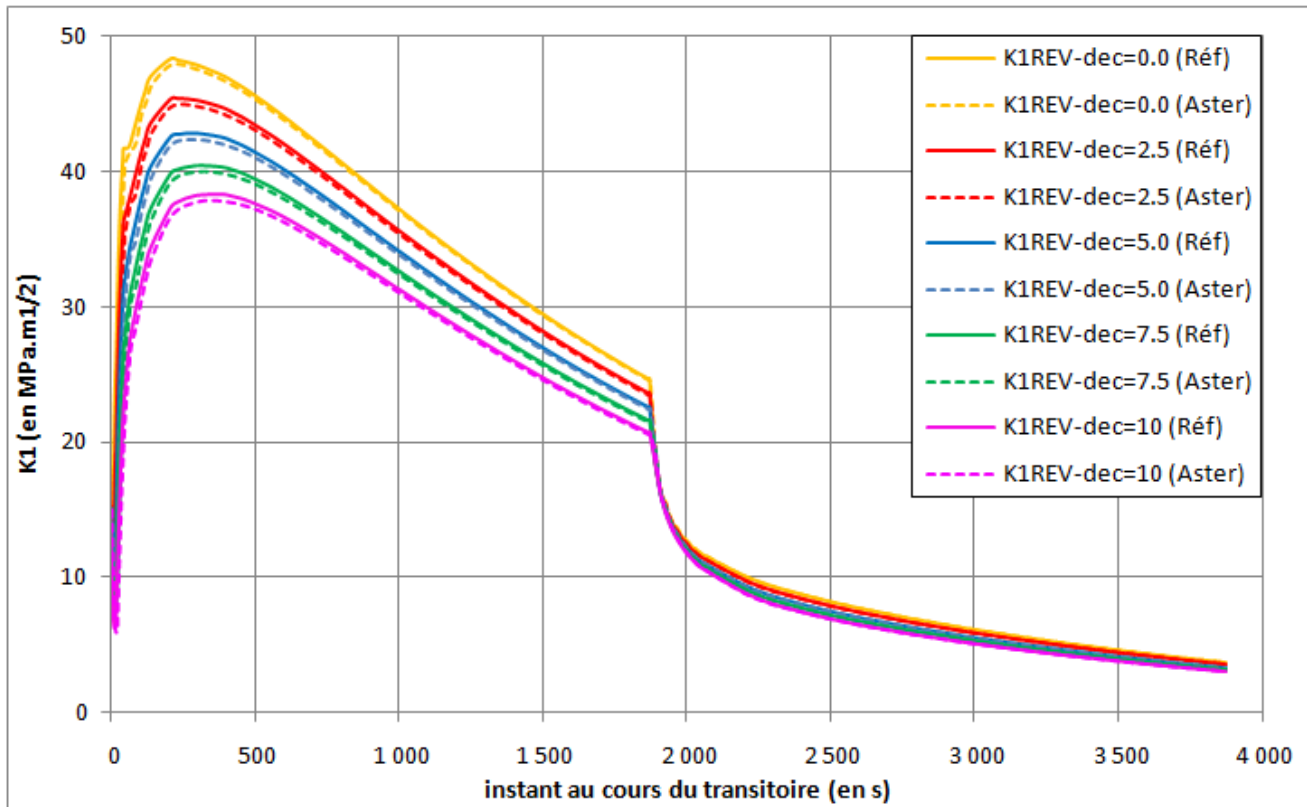

**Figure 3.3-a: Elastic factor of intensity of the constraints for the point side coating**

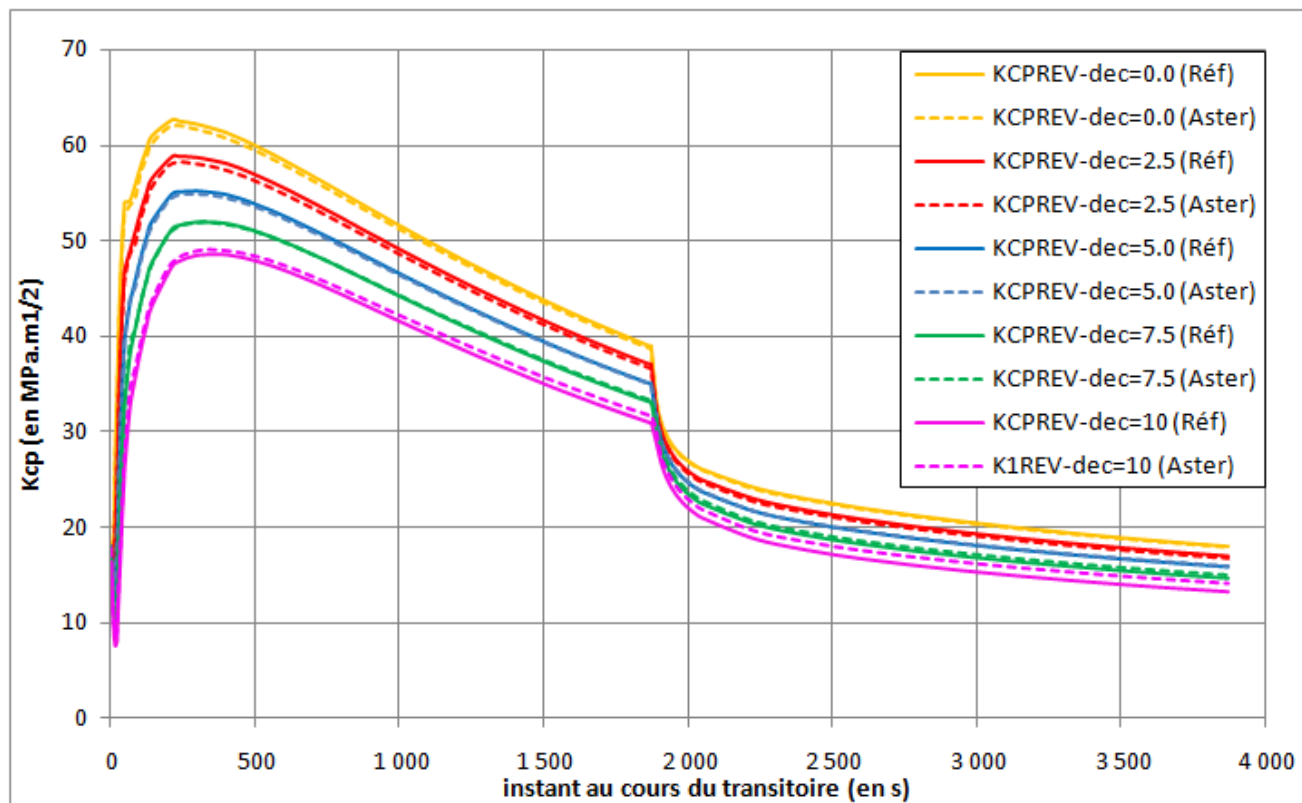
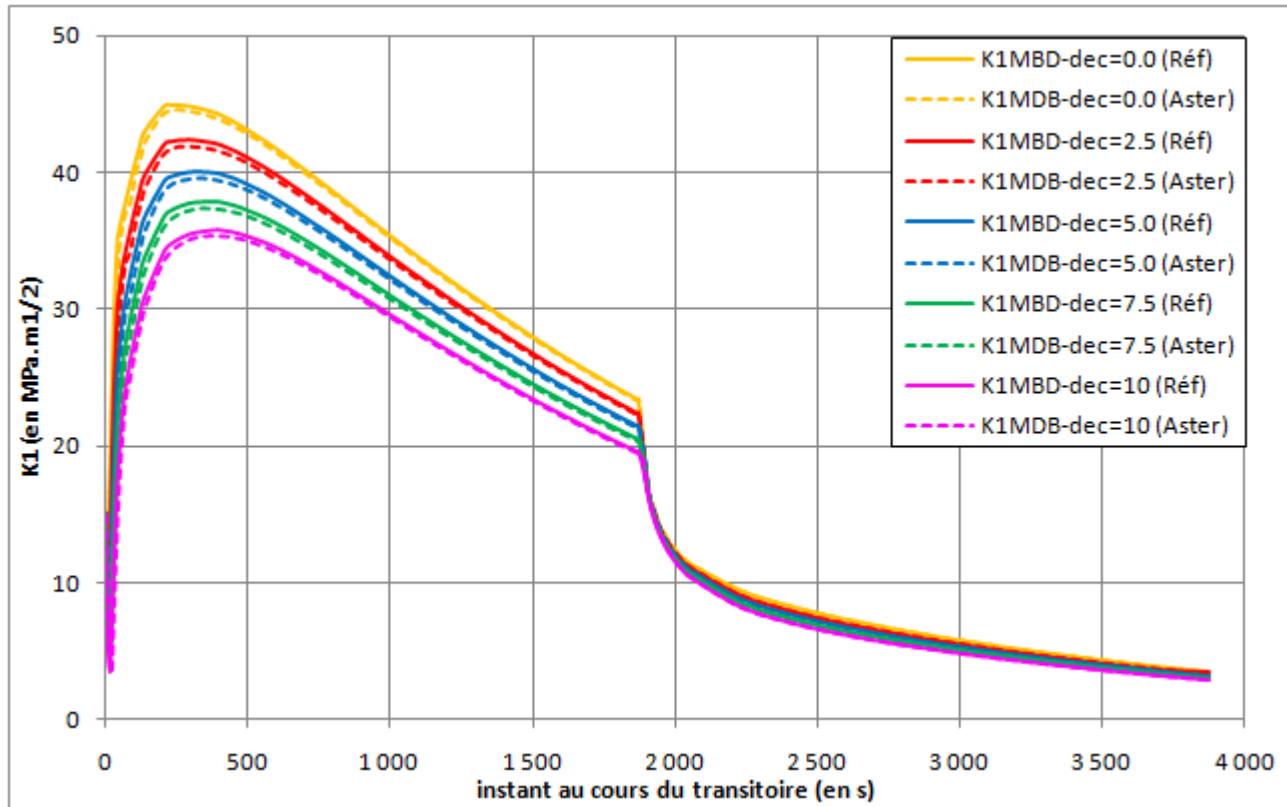

Figure 3.3-b: Elastoplastic factor of intensity of the constraints for the point side coating



**Figure 3.3-c: Elastic factor of intensity of the constraints  
for the point side base metal**

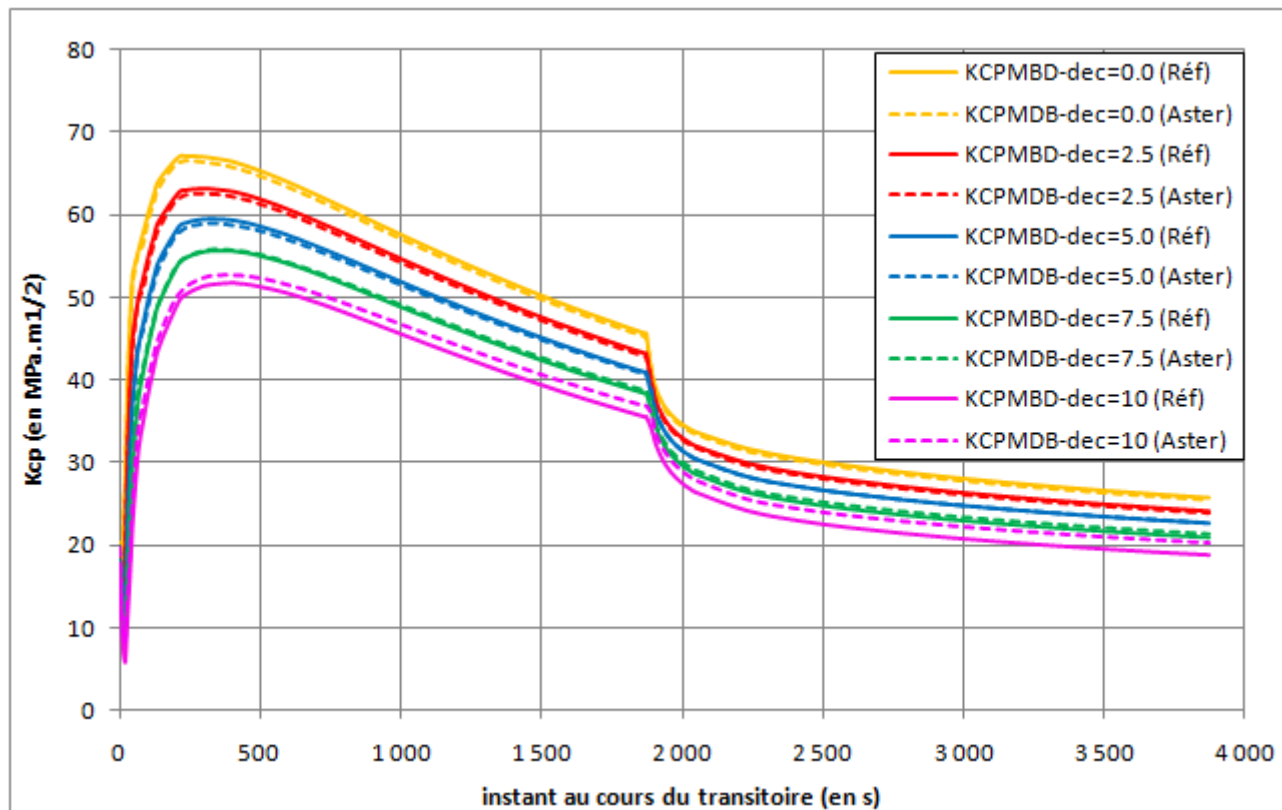

Figure 3.3-d: Elastoplastic factor of intensity of the constraints for the point side base metal

## 4 Summary of the results

---

This case test validates the order `POST_K_BETA` in the case of an elliptic defect shifted in the base metal for modeling of the axisymmetric type.