

WTNV144 - Consolidation of a column of ground poro-élastic saturéE and fracturéE: use of the méthode XFEM

Summary:

It is about a test of validation making it possible to make sure of the good performance of the méthode of éléments finis extended in the case of the MODèof coupling HM in satur mediumé fracturé.

The goal of this test of validation is to test the good taking into account of the discontinuity of the field of pressure in the solid mass on both sides of the fracture as well as the hydraulic behavior of elements HM-XFEM.

It is a question of imposing at the top of a column of ground two different loadings on both sides of the fracture and of observing itévolution of the pressure of pore in each part. This test is similar to the case of validation wtnl100 with only the différence which we introduce into the MODélisation a fracture (of type interfaces) treated by approach XFEM. Résultats is then comparéS with the analytical solution of the case of validation wtnl100.

1 Problem of reference

1.1 Geometry of the problem 2D (modeling A and B)

That is to say a column of ground length $L=LX$ and height $H=10\text{m}$. This column presents in $X=L_d$ a discontinuity of the type interfaces (interface nonwith a grid which is introduced into the model via *level-sets* thanks to the operator `DEFI_FISS_XFEM`). The bar is entirely crossed by discontinuity (on the level of the approximation of the fields of displacement and of pressure of pore of the solid mass, one takes into account only enrichment **Heaviside**).

The temperature within the column is uniform whatever the moment t . The column moreover is more entirely saturated by a fluid (of water for example) and the effects of the forces of gravity are not taken into account.

In order to have a unidimensional solution (according to the direction y reference mark of space) the Poisson's ratio is taken null.

On Figure1.1-1 the geometry of the column of ground is represented.

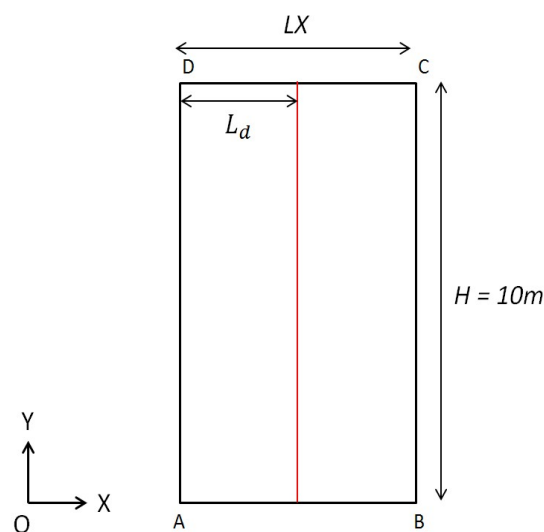

Figure1.1-1: Géométrie problème 2D

1.2 Geometry of the 3D problem (modelings C and D)

That is to say a column of ground length $L=LX$, thickness $E=1\text{m}$ and height $H=10\text{m}$. This column presents in $X=L_d$ a discontinuity of the type interfaces (interface nonwith a grid which is introduced into the model via *level-sets* thanks to the operator `DEFI_FISS_XFEM`). The bar is entirely crossed by discontinuity (on the level of the approximation of the fields of displacement and of pressure of pore of the solid mass, one takes into account only enrichment **Heaviside**).

The temperature within the column is uniform some is the moment t . The column moreover is more entirely saturated by a fluid (of water for example) and the effects of the forces of gravity are not taken into account.

In order to have a unidimensional solution (according to the direction z reference mark of space) the Poisson's ratio is taken null.

On Figure1.2-1 the geometry of the column of ground is represented.

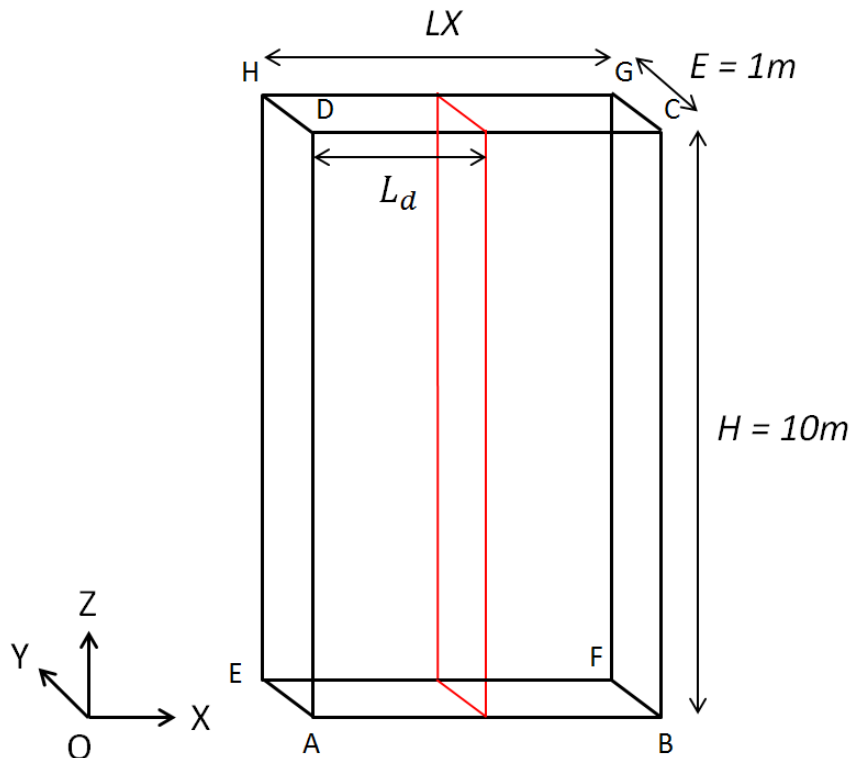

Figure1.2-1: Géométrie problème 3D

1.3 Properties of material

Parameters given in the Table 1.3-1, correspond to the parameters used for modeling in the hydraulic coupled case. The mixing rate used is 'LIQU_SATU'.

Liquid (water)	Viscosity μ_w (en Pa.s) :	10^{-3}
	Module of compressibility $\frac{1}{K_w}$ (en Pa ⁻¹) :	0
	Density of the liquid ρ_w (en kg/m ³) :	1000
	Permeability relating to the fluid $k_{lq}^{rel}(S_{lq})$:	1
Elastic parameters	Young modulus drainé E (en MPa) :	10
	Poisson's ratio ν :	0
Parameters of coupling	Coefficient of Biot b :	1
	Initial homogenized density r_0 (en kg/m ³) :	2800
	Intrinsic permeability K^{int} (en m ² /s) :	10^{-8}

Table 1.3-1 : Properties of material

The porosity of material is taken equalizes with $\varphi = 0,5$.

1.4 Boundary conditions, conditions initial and loadings

1.4.1 Boundary conditions the cases 2D

Displacements are blocked on the faces [AD] and [BC] in the horizontal direction, and on the lower face [AB] as well in the vertical direction as horizontal. On the interface, horizontal displacements are blocked.

The pressure of pore at the top of the column is worthless some is the moment considered, i.e.
 $p(H, t) = 0.0$.

1.4.2 Boundary conditions the cases 3D

Displacements are blocked on face [ABFE]. Displacements according to (Ox) are blocked on faces [EADH], [FBCG] like on the interface. Displacements according to (OY) are blocked on the faces [ABCD] and [EFGH].

The pressure of pore at the top of the column is worthless whatever the moment considered, i.e.
 $p(H, t) = 0.0$.

1.4.3 Loadings and initial conditions

In order to start from a different loading on both sides of the fracture, one seeks with to initially create in the column a discontinuity of the field of pressure on the roof of the column. Thus for the part of the column located with left, the imposed load is $F_G = -1.0 Pa$ and for the part of the column located with right-hand side, the imposed load is $F_D = -1.54 Pa$.

The initial conditions in pressure for hydraulic balance are thus written:

- $p^G(y, 0) = -\frac{F_G}{b} = 1.0 Pa$
- $p^D(y, 0) = -\frac{F_D}{b} = 1.54 Pa$

The boundary conditions are summarized on Figure 1.4.3-1 :

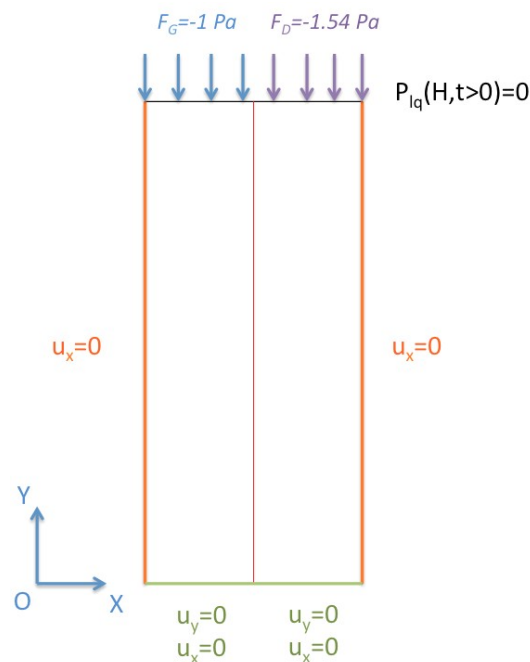

Figure 1.4.3-1 Boundary conditions and initial for modeling 2D

The fracture is indicated in red on Figure 1.4.3-1. No boundary condition is applied to this interface.

1.4.4 Notice on the MODelisation used

Taking into account the discontinuity of the field of pressure at the top of the column [V7.30.100], one notices that:

$$\begin{cases} p(y, 0) = -\frac{F_0}{b} & \text{si } y < H \\ p(y, 0) = 0 & \text{si } y = H \end{cases}$$

This characteristic of the solution confère an instability on the level of the digital resolution (appearance of oscillations) of the problem coupled me at the top of the column. That is related to the name respect of condition LBB [V7.30.100].

Indeed in the classical case, the modeling of the type D_PLAN_HMD is used to reach that point. However in HM-XFEM only extension of modeling D_PLAN_HM was carried out. The results (for case HM-XFEM) got at the top of the column are thus to take with precaution. One observes indeed that the results got with model HM-XFEM are less precise at the top of the column, especially for small times. But these results are similar to those obtained with the modeling of the type D_PLAN_HM in the classical case.

2 Reference solution

2.1 Method of calculating

It is about an analytical solution. This test allowing to validate the discontinuité pressure of the solid mass, we will focus ourselves only on the Résolution HTéoric oféquation of conservation of the mass:

$$\frac{b^2}{E_0} \frac{\partial p_{lq}(y, t)}{\partial t} - \left(\frac{K^{\text{int}} \cdot k_{lq}^{\text{rel}}}{\mu_{lq}} \frac{\partial^2 p_{lq}(y, t)}{\partial y^2} \right) = 0$$

differential equation above being homogeneous, with constant coefficients, one uses the method of resolution by separable variables (see appendix 1 for the solution of this equation).

Taking into account the initial conditions and the limits considered in the paragraph 1.4 the expression of the pressure of pore for the left-hand column is expressed by:

$$P^G(y, t) = \frac{-4F_G}{\pi b} \sum_{m=1}^{+\infty} \frac{(-1)^{m-1}}{2m-1} e^{-\lambda E \pi^2 (2m-1)^2 \frac{t}{4b^2 H^2}} \cos\left(\frac{\pi y (2m-1)}{2H}\right)$$

and the expression of the pressure of pore for the column of right-hand side is expressed by:

$$P^D(y, t) = \frac{-4F_D}{\pi b} \sum_{m=1}^{+\infty} \frac{(-1)^{m-1}}{2m-1} e^{-\lambda E \pi^2 (2m-1)^2 \frac{t}{4b^2 H^2}} \cos\left(\frac{\pi y (2m-1)}{2H}\right)$$

2.2 Sizes and results of reference

The pressure of pore is tested PRE1 and the constraint SIYY with various heights in the column and various moments.

2.3 Uncertainties on the solution

The no solution is analytical.

3 Modeling A

3.1 Characteristics of modeling A

The characteristics are identical to the reference solution. Modeling used is of type D_PLAN_HM. The grid is represented on Figure 3.1-1. In this modeling, $LX=4m$ and $L_d=2m$, discontinuity is thus in conformity with the grid.

Figure 3.1-1 grid 2D modeling A

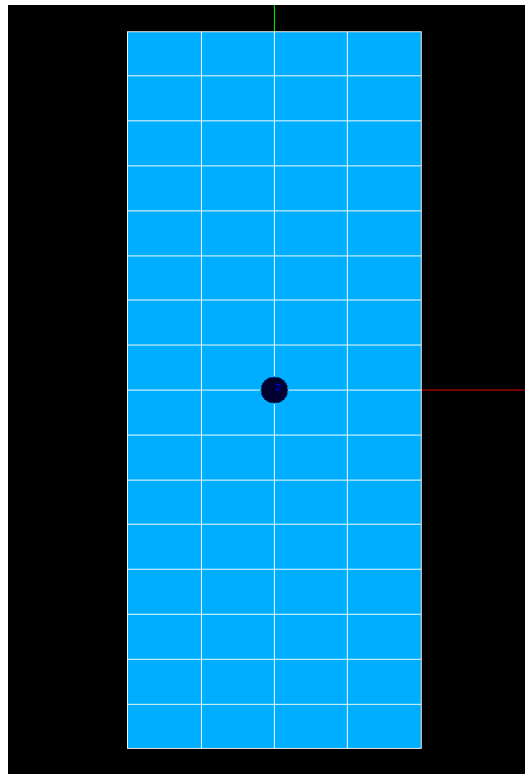

3.2 Sizes tested and results

In the left-hand column, one tests the pressure of pore PRE1 and the constraint SIYY at the final moment $t=250s$ with various heights in the column. The got results are similar to those obtained for a modeling D_PLAN_HM classic but slightly less less precise than those obtained with a modeling D_PLAN_HMD classic in the top of the column.

Value tested	Height (m)	Moment (S)	Type	Reference
Displacement PRE1	8.75	0.	ANALYTICAL	1.0
Displacement PRE1	9,375	0.	ANALYTICAL	1.0
Displacement PRE1	0.0	250.	ANALYTICAL	0.68544576689
Displacement PRE1	0,625	250.	ANALYTICAL	0.682208147164
Displacement PRE1	1.25	250.	ANALYTICAL	0.67252104433
Displacement PRE1	1,875	250.	ANALYTICAL	0.656461946263
Displacement PRE1	2.5	250.	ANALYTICAL	0.634160686593
Displacement PRE1	3,125	250.	ANALYTICAL	0.605800331394
Displacement PRE1	3.75	250.	ANALYTICAL	0.571618145927
Displacement PRE1	4,375	250.	ANALYTICAL	0.531906397249
Displacement PRE1	5.0	250.	ANALYTICAL	0.487012719208
Displacement PRE1	5,625	250.	ANALYTICAL	0.437339762565
Displacement PRE1	6.25	250.	ANALYTICAL	0.38334387542

Displacement PRE1	6,875	250.	ANALYTICAL	0.32553260623
Displacement PRE1	7.5	250.	ANALYTICAL	0.264460889851
Displacement PRE1	8,125	250.	ANALYTICAL	0.200725860656
Displacement PRE1	8.75	250.	ANALYTICAL	0.134960328921
Displacement PRE1	9,375	250.	ANALYTICAL	0.0678250497631
Displacement PRE1	10.0	250.	ANALYTICAL	0.00
Constraint SIYY	8.75	0.00	ANALYTICAL	0.00
Constraint SIYY	0.0	250.	ANALYTICAL	-0.31455423311
Constraint SIYY	0,625	250.	ANALYTICAL	-0.317791852836
Constraint SIYY	1.25	250.	ANALYTICAL	-0.32747895567
Constraint SIYY	1,875	250.	ANALYTICAL	-0.343538053737
Constraint SIYY	2.5	250.	ANALYTICAL	-0.365839313407
Constraint SIYY	3,125	250.	ANALYTICAL	-0.394199668606
Constraint SIYY	3.75	250.	ANALYTICAL	-0.428381854073
Constraint SIYY	4,375	250.	ANALYTICAL	-0.468093602751
Constraint SIYY	5.0	250.	ANALYTICAL	-0.512987280792
Constraint SIYY	5,625	250.	ANALYTICAL	-0.562660237435
Constraint SIYY	6.25	250.	ANALYTICAL	-0.61665612458
Constraint SIYY	6,875	250.	ANALYTICAL	-0.67446739377
Constraint SIYY	7.5	250.	ANALYTICAL	-0.735539110149
Constraint SIYY	8,125	250.	ANALYTICAL	-0.799274139344
Constraint SIYY	8.75	250.	ANALYTICAL	-0.865039671079
Constraint SIYY	9,375	250.	ANALYTICAL	-0.932174950237
Constraint SIYY	10.0	250.	ANALYTICAL	-1.0
Constraint VMIS	10.0	250.	NON_REGRESSION	1.0
Constraint VMIS SG	10.0	250.	NON_REGRESSION	-1.0
Constraint PRIN 1	10.0	250.	NON_REGRESSION	-1.0
Constraint PRIN 2	10.0	250.	NON_REGRESSION	0.00
Constraint PRIN 3	10.0	250.	NON_REGRESSION	0.00
Constraint TRESCA	10.0	250.	NON_REGRESSION	1.0

Results got for the pressure of pore at the final moment $t=250s$ are represented on Figure 3.2-1 . One observes well a clear discontinuity of the pressure of pore on both sides of the crack. QUAD8 exchanges are subdivided under SORTED HM_XFEM.

Figure 3.2-1 Pressure of pore at the moment $t=250s$

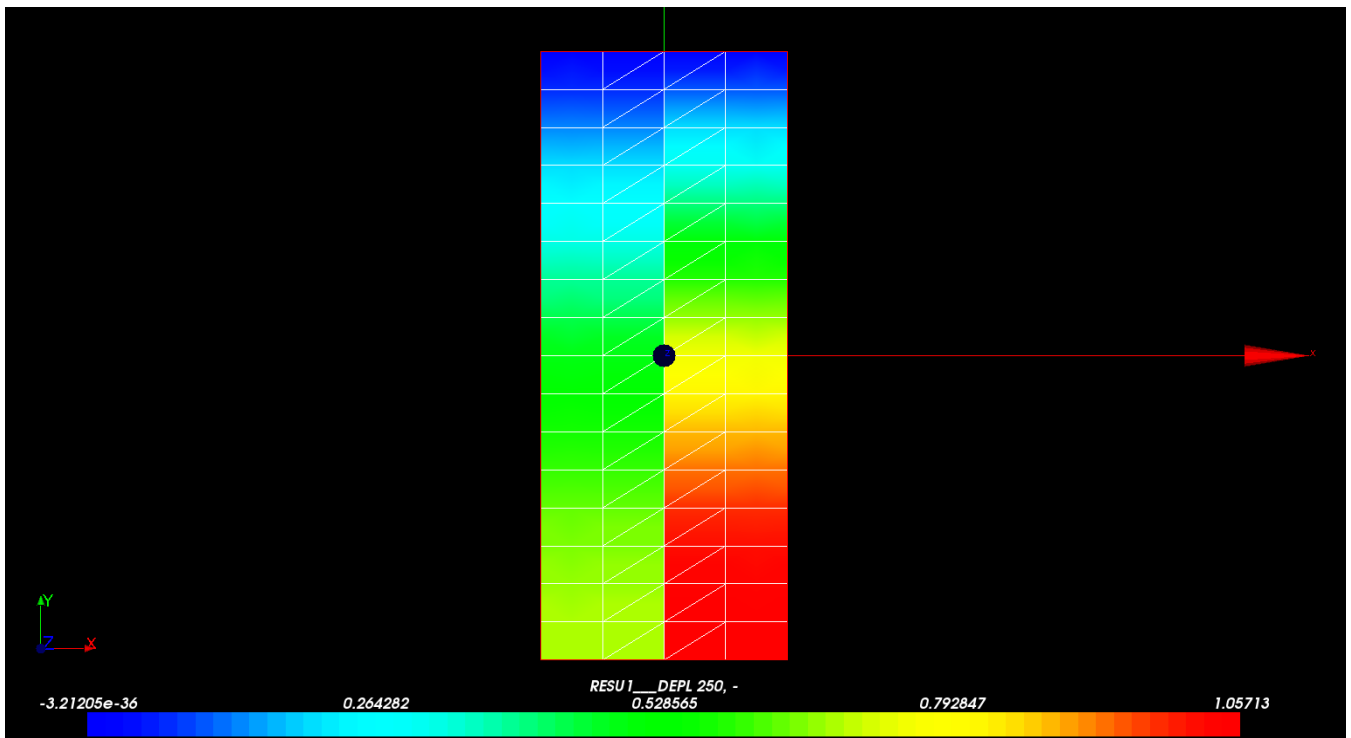

In the column of right-hand side, one tests the pressure of pore PRE1 and the constraint SIYY at the final moment $t=250s$ with various heights in the column. The got results are similar to those obtained for a modeling D_PLAN_HM classic but slightly less precise than those obtained with a modeling D_PLAN_HMD classic in the top of the column.

Value tested	Height (m)	Moment (S)	Type	Reference
Displacement PRE1	8.75	0.	ANALYTICAL	1.54
Displacement PRE1	9,375	0.	ANALYTICAL	1.54
Displacement PRE1	0.0	250.	ANALYTICAL	1.055586481
Displacement PRE1	0,625	250.	ANALYTICAL	1.050600547
Displacement PRE1	1.25	250.	ANALYTICAL	1.035682408
Displacement PRE1	1,875	250.	ANALYTICAL	1.010951397
Displacement PRE1	2.5	250.	ANALYTICAL	0.9766074572
Displacement PRE1	3,125	250.	ANALYTICAL	0.9329325102
Displacement PRE1	3.75	250.	ANALYTICAL	0.8802919447
Displacement PRE1	4,375	250.	ANALYTICAL	0.8191358517
Displacement PRE1	5.0	250.	ANALYTICAL	0.7499995876
Displacement PRE1	5,625	250.	ANALYTICAL	0.6735032343
Displacement PRE1	6.25	250.	ANALYTICAL	0.5903495681
Displacement PRE1	6,875	250.	ANALYTICAL	0.5013202135
Displacement PRE1	7.5	250.	ANALYTICAL	0.4072697703
Displacement PRE1	8,125	250.	ANALYTICAL	0.3091178253
Displacement PRE1	8.75	250.	ANALYTICAL	0.207838906
Displacement PRE1	9,375	250.	ANALYTICAL	0.104450576
Displacement PRE1	10.0	250.	ANALYTICAL	0.00
Constraint SIYY	8.75	0.00	ANALYTICAL	0.00
Constraint SIYY	0.0	250.	ANALYTICAL	-0.484413519
Constraint SIYY	0,625	250.	ANALYTICAL	-0.489399453
Constraint SIYY	1.25	250.	ANALYTICAL	-0.504317591
Constraint SIYY	1,875	250.	ANALYTICAL	-0.529048602
Constraint SIYY	2.5	250.	ANALYTICAL	-0.563392542
Constraint SIYY	3,125	250.	ANALYTICAL	-0.607067489
Constraint SIYY	3.75	250.	ANALYTICAL	-0.659708055
Constraint SIYY	4,375	250.	ANALYTICAL	-0.720864148
Constraint SIYY	5.0	250.	ANALYTICAL	-0.790000412
Constraint SIYY	5,625	250.	ANALYTICAL	-0.866496765
Constraint SIYY	6.25	250.	ANALYTICAL	-0.949650431
Constraint SIYY	6,875	250.	ANALYTICAL	-1.038679786
Constraint SIYY	7.5	250.	ANALYTICAL	-1.13273023
Constraint SIYY	8,125	250.	ANALYTICAL	-1.230882175
Constraint SIYY	8.75	250.	ANALYTICAL	-1.332161093
Constraint SIYY	9,375	250.	ANALYTICAL	-1.435549423
Constraint SIYY	10.0	250.	ANALYTICAL	-1.54
Constraint VMIS	10.0	250.	NON_REGRESSION	1.54
Constraint VMIS_SG	10.0	250.	NON_REGRESSION	-1.54
Constraint PRIN_1	10.0	250.	NON_REGRESSION	-1.54
Constraint PRIN_2	10.0	250.	NON_REGRESSION	0.00
Constraint PRIN_3	10.0	250.	NON_REGRESSION	0.00
Constraint TRESCA	10.0	250.	NON_REGRESSION	1.54

4 Modeling B

4.1 Characteristics of modeling B

The characteristics are identical to the reference solution. Modeling used is of type D_PLAN_HM. The grid is represented on Figure 4.1-1. In this modeling, $LX=5m$ and $L_d=2,6m$, discontinuity is thus nonin conformity with the grid, it crosses QUAD8.

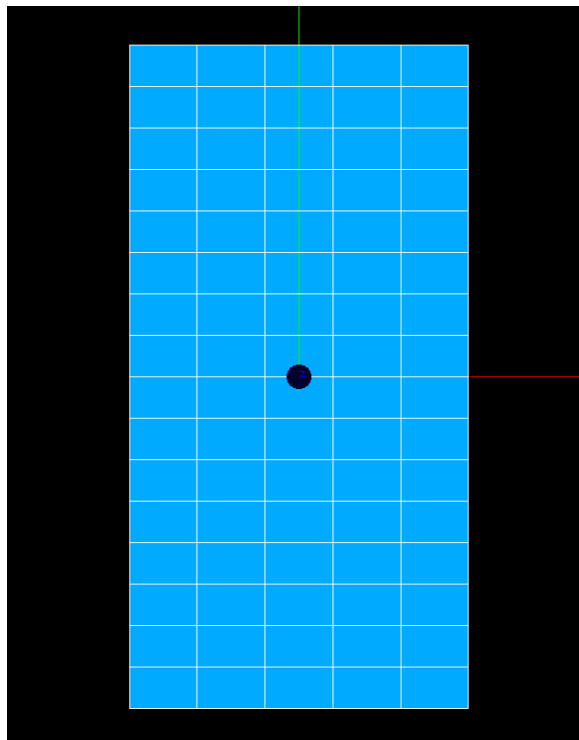

Figure 4.1-1 grid 2D modeling B

4.2 Sizes tested and results

In the left-hand column, one tests the pressure of pore PRE1 and the constraint SIYY at the final moment $t=250s$ with various heights in the column. The got results are similar to those obtained for a modeling D_PLAN_HM classic but slightly less precise than those obtained with a modeling D_PLAN_HMD classic in the top of the column.

Value tested	Height (m)	Moment (S)	Type	Reference
Displacement PRE1	8.75	0.	ANALYTICAL	1.0
Displacement PRE1	9,375	0.	ANALYTICAL	1.0
Displacement PRE1	0.0	250.	ANALYTICAL	0.68544576689
Displacement PRE1	0,625	250.	ANALYTICAL	0.682208147164
Displacement PRE1	1.25	250.	ANALYTICAL	0.67252104433
Displacement PRE1	1,875	250.	ANALYTICAL	0.656461946263
Displacement PRE1	2.5	250.	ANALYTICAL	0.634160686593
Displacement PRE1	3,125	250.	ANALYTICAL	0.605800331394
Displacement PRE1	3.75	250.	ANALYTICAL	0.571618145927
Displacement PRE1	4,375	250.	ANALYTICAL	0.531906397249
Displacement PRE1	5.0	250.	ANALYTICAL	0.487012719208

Warning : The translation process used on this website is a "Machine Translation". It may be imprecise and inaccurate in whole or in part and is provided as a convenience.

Displacement PRE1	5,625	250.	ANALYTICAL	0.437339762565
Displacement PRE1	6,25	250.	ANALYTICAL	0.38334387542
Displacement PRE1	6,875	250.	ANALYTICAL	0.32553260623
Displacement PRE1	7,5	250.	ANALYTICAL	0.264460889851
Displacement PRE1	8,125	250.	ANALYTICAL	0.200725860656
Displacement PRE1	8,75	250.	ANALYTICAL	0.134960328921
Displacement PRE1	9,375	250.	ANALYTICAL	0.0678250497631
Displacement PRE1	10,0	250.	ANALYTICAL	0.00
Constraint SIYY	8,75	0.00	ANALYTICAL	0.00
Constraint SIYY	0,0	250.	ANALYTICAL	-0.31455423311
Constraint SIYY	0,625	250.	ANALYTICAL	-0.317791852836
Constraint SIYY	1,25	250.	ANALYTICAL	-0.32747895567
Constraint SIYY	1,875	250.	ANALYTICAL	-0.343538053737
Constraint SIYY	2,5	250.	ANALYTICAL	-0.365839313407
Constraint SIYY	3,125	250.	ANALYTICAL	-0.394199668606
Constraint SIYY	3,75	250.	ANALYTICAL	-0.428381854073
Constraint SIYY	4,375	250.	ANALYTICAL	-0.468093602751
Constraint SIYY	5,0	250.	ANALYTICAL	-0.512987280792
Constraint SIYY	5,625	250.	ANALYTICAL	-0.562660237435
Constraint SIYY	6,25	250.	ANALYTICAL	-0.61665612458
Constraint SIYY	6,875	250.	ANALYTICAL	-0.67446739377
Constraint SIYY	7,5	250.	ANALYTICAL	-0.735539110149
Constraint SIYY	8,125	250.	ANALYTICAL	-0.799274139344
Constraint SIYY	8,75	250.	ANALYTICAL	-0.865039671079
Constraint SIYY	9,375	250.	ANALYTICAL	-0.932174950237
Constraint SIYY	10,0	250.	ANALYTICAL	-1.0
Constraint VMIS	10,0	250.	NON_REGRESSION	1.0
Constraint VMIS SG	10,0	250.	NON_REGRESSION	-1.0
Constraint PRIN_1	10,0	250.	NON_REGRESSION	-1.0
Constraint PRIN_2	10,0	250.	NON_REGRESSION	0.00
Constraint PRIN_3	10,0	250.	NON_REGRESSION	0.00
Constraint TRESCA	10,0	250.	NON_REGRESSION	1.0

Results got for the pressure of pore at the final moment $t=250s$ are represented on Figure 4.2-1 . One observes well a clear discontinuity of the pressure of pore on both sides of the crack. QUAD8 exchanges are subdivided under TRIA6 HM_XFEM.

Figure 4.2-1 Pressure of pore at the moment $t=250s$

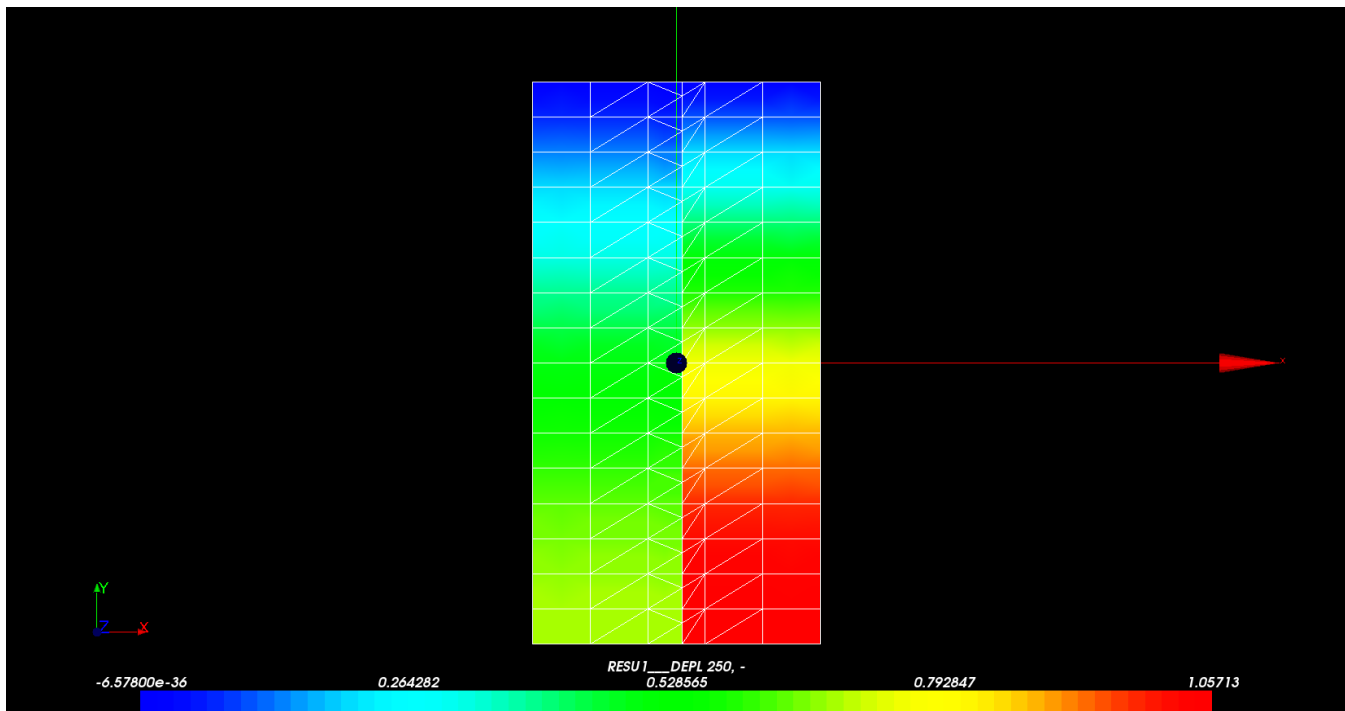

In the column of right-hand side, one tests the pressure of pore PRE1 and the constraint SIYY at the final moment $t=250s$ with various heights in the column. The got results are similar to those obtained for a modeling D_PLAN_HM classic but slightly less less precise than those obtained with a modeling D_PLAN_HMD classic in the top of the column.

Value tested	Height (m)	Moment (S)	Type	Reference
Displacement PRE1	8.75	0.	ANALYTICAL	1.54
Displacement PRE1	9,375	0.	ANALYTICAL	1.54
Displacement PRE1	0.0	250.	ANALYTICAL	1.055586481
Displacement PRE1	0,625	250.	ANALYTICAL	1.050600547
Displacement PRE1	1.25	250.	ANALYTICAL	1.035682408
Displacement PRE1	1,875	250.	ANALYTICAL	1.010951397
Displacement PRE1	2.5	250.	ANALYTICAL	0.9766074572
Displacement PRE1	3,125	250.	ANALYTICAL	0.9329325102
Displacement PRE1	3.75	250.	ANALYTICAL	0.8802919447
Displacement PRE1	4,375	250.	ANALYTICAL	0.8191358517
Displacement PRE1	5.0	250.	ANALYTICAL	0.7499995876
Displacement PRE1	5,625	250.	ANALYTICAL	0.6735032343
Displacement PRE1	6.25	250.	ANALYTICAL	0.5903495681
Displacement PRE1	6,875	250.	ANALYTICAL	0.5013202135
Displacement PRE1	7.5	250.	ANALYTICAL	0.4072697703
Displacement PRE1	8,125	250.	ANALYTICAL	0.3091178253
Displacement PRE1	8.75	250.	ANALYTICAL	0.207838906
Displacement PRE1	9,375	250.	ANALYTICAL	0.104450576
Displacement PRE1	10.0	250.	ANALYTICAL	0.00
Constraint SIYY	8.75	0.00	ANALYTICAL	0.00
Constraint SIYY	0.0	250.	ANALYTICAL	-0.484413519
Constraint SIYY	0,625	250.	ANALYTICAL	-0.489399453
Constraint SIYY	1.25	250.	ANALYTICAL	-0.504317591
Constraint SIYY	1,875	250.	ANALYTICAL	-0.529048602
Constraint SIYY	2.5	250.	ANALYTICAL	-0.563392542
Constraint SIYY	3,125	250.	ANALYTICAL	-0.607067489
Constraint SIYY	3.75	250.	ANALYTICAL	-0.659708055
Constraint SIYY	4,375	250.	ANALYTICAL	-0.720864148
Constraint SIYY	5.0	250.	ANALYTICAL	-0.790000412
Constraint SIYY	5,625	250.	ANALYTICAL	-0.866496765
Constraint SIYY	6.25	250.	ANALYTICAL	-0.949650431
Constraint SIYY	6,875	250.	ANALYTICAL	-1.038679786
Constraint SIYY	7.5	250.	ANALYTICAL	-1.13273023
Constraint SIYY	8,125	250.	ANALYTICAL	-1.230882175
Constraint SIYY	8.75	250.	ANALYTICAL	-1.332161093
Constraint SIYY	9,375	250.	ANALYTICAL	-1.435549423
Constraint SIYY	10.0	250.	ANALYTICAL	-1.54
Constraint VMIS	10.0	250.	NON_REGRESSION	1.54
Constraint VMIS_SG	10.0	250.	NON_REGRESSION	-1.54
Constraint PRIN_1	10.0	250.	NON_REGRESSION	-1.54
Constraint PRIN_2	10.0	250.	NON_REGRESSION	0.00
Constraint PRIN_3	10.0	250.	NON_REGRESSION	0.00
Constraint TRESCA	10.0	250.	NON_REGRESSION	1.54

5 Modeling C

5.1 Characteristics of modeling C

The characteristics are identical to the reference solution. Modeling used is of type 3D_HM. The grid is represented on Figure 5.1-1, it consists of 64 HEXA20. In this modeling, $LX=4m$ and $L_d=2m$, discontinuity is thus in conformity with the grid.

Figure 5.1-1 grid 3D modeling C

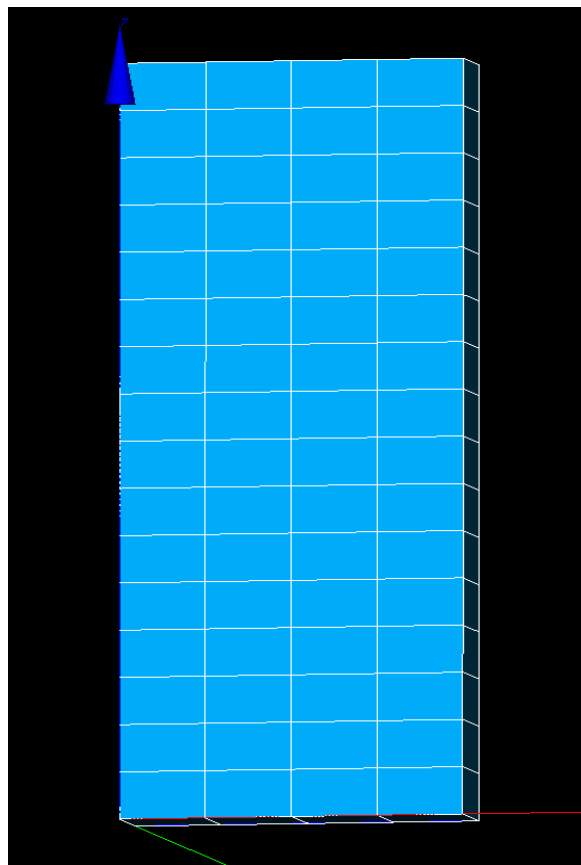

5.2 Sizes tested and results

In the left-hand column, one tests the pressure of pore PRE1 at the moment $t=0,0001s$ with various heights in the column. The got results are similar to those obtained for a modeling 3D_HM classic but slightly less less precise than those obtained with a modeling 3D_HMD classic in the top of the column.

Value tested	Height (m)	Moment (S)	Type	Reference
Displacement PRE1	0.0	0.0001	ANALYTICAL	1.0
Displacement PRE1	0.625	0.0001	ANALYTICAL	1.0
Displacement PRE1	1.25	0.0001	ANALYTICAL	1.0
Displacement PRE1	1.875	0.0001	ANALYTICAL	1.0
Displacement PRE1	2.5	0.0001	ANALYTICAL	1.0
Displacement PRE1	3.125	0.0001	ANALYTICAL	1.0
Displacement PRE1	3.75	0.0001	ANALYTICAL	1.0
Displacement PRE1	4.375	0.0001	ANALYTICAL	1.0
Displacement PRE1	5.0	0.0001	ANALYTICAL	1.0
Displacement PRE1	5.625	0.0001	ANALYTICAL	1.0

Warning : The translation process used on this website is a "Machine Translation". It may be imprecise and inaccurate in whole or in part and is provided as a convenience.

Copyright 2019 EDF R&D - Licensed under the terms of the GNU FDL (<http://www.gnu.org/copyleft/fdl.html>)

Displacement PRE1	6.25	0.0001	ANALYTICAL	1.0
Displacement PRE1	6.875	0.0001	ANALYTICAL	1.0
Displacement PRE1	7.5	0.0001	ANALYTICAL	1.0
Displacement PRE1	8.125	0.0001	ANALYTICAL	1.0
Displacement PRE1	8.75	0.0001	ANALYTICAL	1.0
Displacement PRE1	9.375	0.0001	ANALYTICAL	1.0
Displacement PRE1	10.0	0.0001	ANALYTICAL	0.0

Results got for the pressure of pore at the final moment $t=0.0001s$ are represented on Figure 5.2-1 . One observes well a clear discontinuity of the pressure of pore on both sides of the crack. HEXA20 exchanges are subdivided under TETRA HM_XFEM.

Figure 5.2-1 Pressure of pore at the moment $t=0.001s$

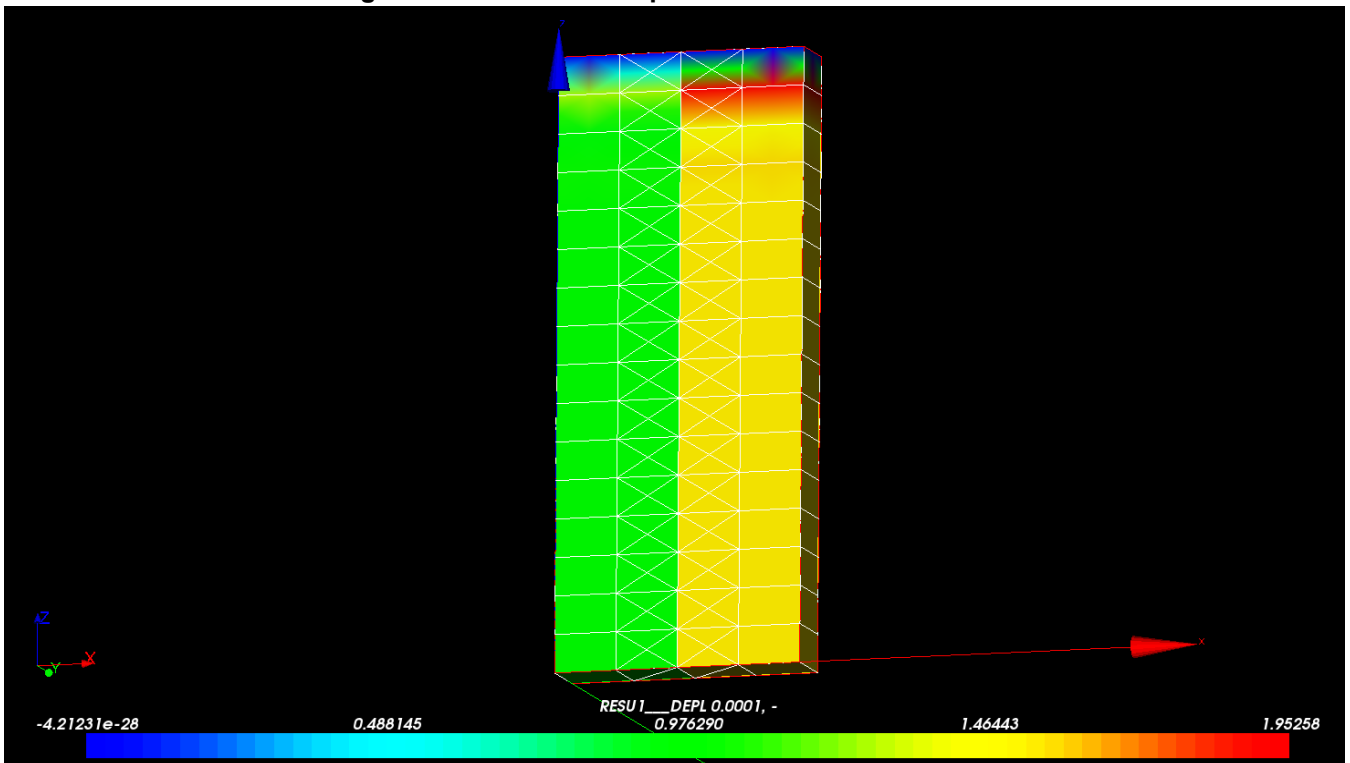

In the column of right-hand side, one tests the pressure of pore PRE1 at the moment $t=0,0001s$ with various heights in the column. The got results are similar to those obtained for a modeling 3D_HM classic but slightly less less precise than those obtained with a modeling 3D_HMD classic in the top of the column.

Value tested	Height (m)	Moment (S)	Type	Reference
Displacement PRE1	0.0	0.0001	ANALYTICAL	1.54
Displacement PRE1	0.625	0.0001	ANALYTICAL	1.54
Displacement PRE1	1.25	0.0001	ANALYTICAL	1.54
Displacement PRE1	1.875	0.0001	ANALYTICAL	1.54
Displacement PRE1	2.5	0.0001	ANALYTICAL	1.54
Displacement PRE1	3.125	0.0001	ANALYTICAL	1.54
Displacement PRE1	3.75	0.0001	ANALYTICAL	1.54
Displacement PRE1	4.375	0.0001	ANALYTICAL	1.54
Displacement PRE1	5.0	0.0001	ANALYTICAL	1.54
Displacement PRE1	5.625	0.0001	ANALYTICAL	1.54
Displacement PRE1	6.25	0.0001	ANALYTICAL	1.54
Displacement PRE1	6.875	0.0001	ANALYTICAL	1.54
Displacement PRE1	7.5	0.0001	ANALYTICAL	1.54
Displacement PRE1	8.125	0.0001	ANALYTICAL	1.54
Displacement PRE1	8.75	0.0001	ANALYTICAL	1.54
Displacement PRE1	9.375	0.0001	ANALYTICAL	1.54
Displacement PRE1	10.0	0.0001	ANALYTICAL	0.0

6 Modeling D

6.1 Characteristics of modeling D

The characteristics are identical to the reference solution. Modeling used is of type 3D_HM. The grid is represented on Figure 6.1-1, it consists of 80 HEXA20. In this modeling, $LX=5m$ and $L_d=2,6m$, discontinuity is thus nonin conformity with the grid. HEXA20 exchanges are crossed by the crack.

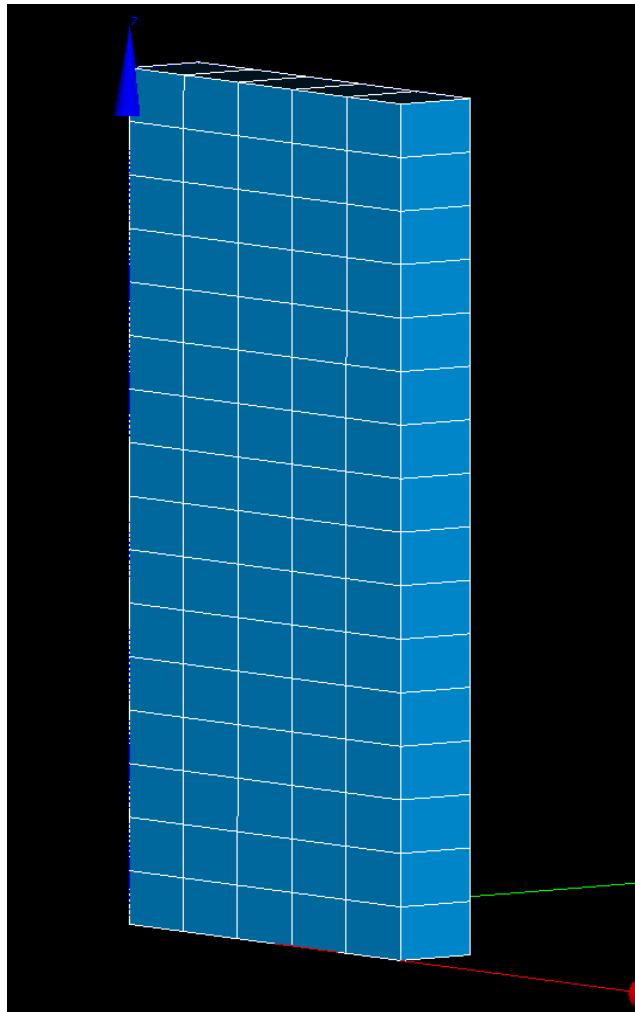

Figure 6.1-1 grid 3D modeling D

6.2 Sizes tested and results

In the left-hand column, one tests the pressure of pore PRE1 at the moment $t=0,0001s$ with various heights in the column. The got results are similar to those obtained for a modeling 3D_HM classic but slightly less less precise than those obtained with a modeling 3D_HMD classic in the top of the column.

Value tested	Height (m)	Moment (S)	Type	Reference
Displacement PRE1	0.0	0.0001	ANALYTICAL	1.0
Displacement PRE1	0.625	0.0001	ANALYTICAL	1.0

Warning : The translation process used on this website is a "Machine Translation". It may be imprecise and inaccurate in whole or in part and is provided as a convenience.

Copyright 2019 EDF R&D - Licensed under the terms of the GNU FDL (<http://www.gnu.org/copyleft/fdl.html>)

Displacement PRE1	1.25	0.0001	ANALYTICAL	1.0
Displacement PRE1	1.875	0.0001	ANALYTICAL	1.0
Displacement PRE1	2.5	0.0001	ANALYTICAL	1.0
Displacement PRE1	3.125	0.0001	ANALYTICAL	1.0
Displacement PRE1	3.75	0.0001	ANALYTICAL	1.0
Displacement PRE1	4.375	0.0001	ANALYTICAL	1.0
Displacement PRE1	5.0	0.0001	ANALYTICAL	1.0
Displacement PRE1	5.625	0.0001	ANALYTICAL	1.0
Displacement PRE1	6.25	0.0001	ANALYTICAL	1.0
Displacement PRE1	6.875	0.0001	ANALYTICAL	1.0
Displacement PRE1	7.5	0.0001	ANALYTICAL	1.0
Displacement PRE1	8.125	0.0001	ANALYTICAL	1.0
Displacement PRE1	8.75	0.0001	ANALYTICAL	1.0
Displacement PRE1	9.375	0.0001	ANALYTICAL	1.0
Displacement PRE1	10.0	0.0001	ANALYTICAL	0.0

Results got for the pressure of pore at the final moment $t=0.0001s$ are represented on Figure 6.2-1 . One observes well a clear discontinuity of the pressure of pore on both sides of the crack. HEXA20 exchanges are subdivided under TETRA HM_XFEM.

Figure 6.2-1 Pressure of pore at the moment $t=0.001s$

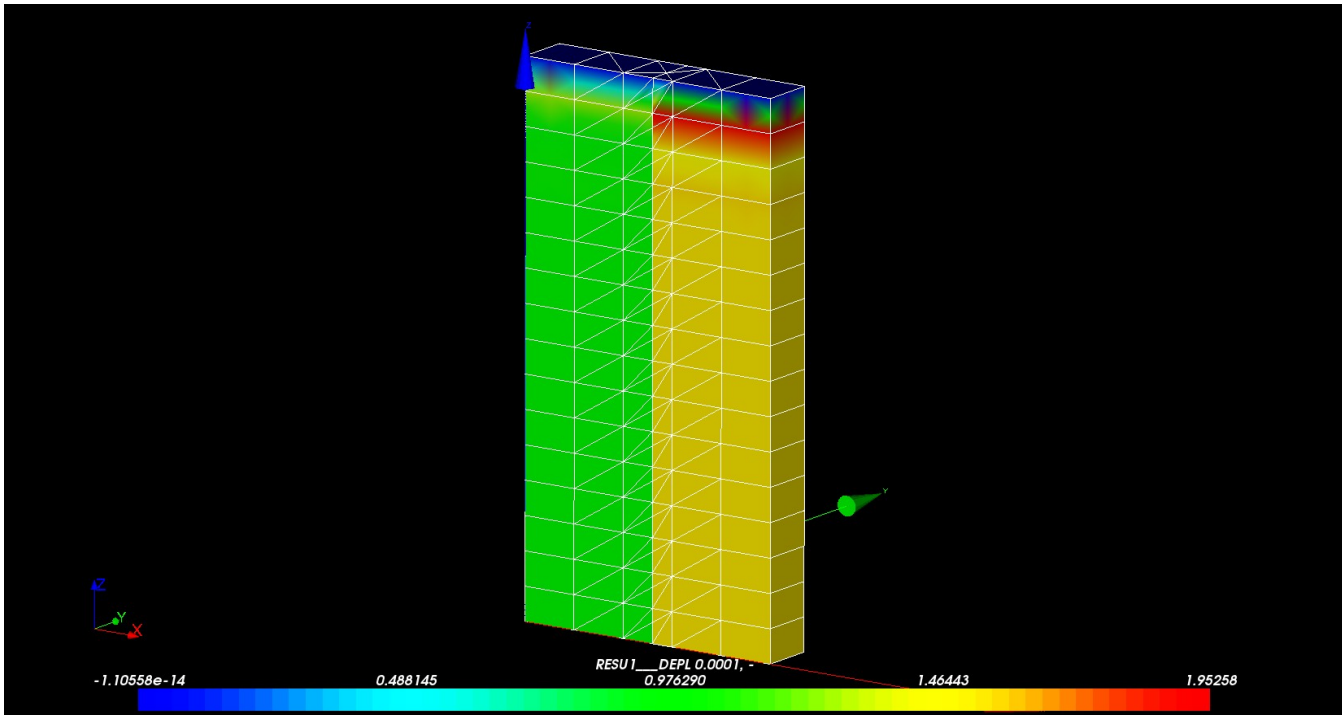

In the column of right-hand side, one tests the pressure of pore PRE1 at the moment $t=0,0001s$ with various heights in the column. The got results are similar to those obtained for a modeling 3D_HM classic but slightly less less precise than those obtained with a modeling 3D_HMD classic in the top of the column.

Value tested	Height (m)	Moment (S)	Type	Reference
Displacement PRE1	0.0	0.0001	ANALYTICAL	1.54
Displacement PRE1	0.625	0.0001	ANALYTICAL	1.54
Displacement PRE1	1.25	0.0001	ANALYTICAL	1.54
Displacement PRE1	1.875	0.0001	ANALYTICAL	1.54
Displacement PRE1	2.5	0.0001	ANALYTICAL	1.54
Displacement PRE1	3.125	0.0001	ANALYTICAL	1.54
Displacement PRE1	3.75	0.0001	ANALYTICAL	1.54
Displacement PRE1	4.375	0.0001	ANALYTICAL	1.54
Displacement PRE1	5.0	0.0001	ANALYTICAL	1.54

Displacement PRE1	5.625	0.0001	ANALYTICAL	1.54
Displacement PRE1	6.25	0.0001	ANALYTICAL	1.54
Displacement PRE1	6.875	0.0001	ANALYTICAL	1.54
Displacement PRE1	7.5	0.0001	ANALYTICAL	1.54
Displacement PRE1	8.125	0.0001	ANALYTICAL	1.54
Displacement PRE1	8.75	0.0001	ANALYTICAL	1.54
Displacement PRE1	9.375	0.0001	ANALYTICAL	1.54
Displacement PRE1	10.0	0.0001	ANALYTICAL	0.0

7 Conclusion

For each of two modelings, the results agree with the analytical solution like with the results got with a classical modeling HM for each side of the interface. The degree of freedom of pressure enriched `HPRE1` is correctly introduced and the hydraulic behavior of elements HM-XFEM coincides with that of classical elements HM.